

MEDIDA DO PRODUTO MONTADO

MEASURE OF THE ASSEMBLED PRODUCT
MEDIDA DEL PRODUCTO ENSAMBLADO

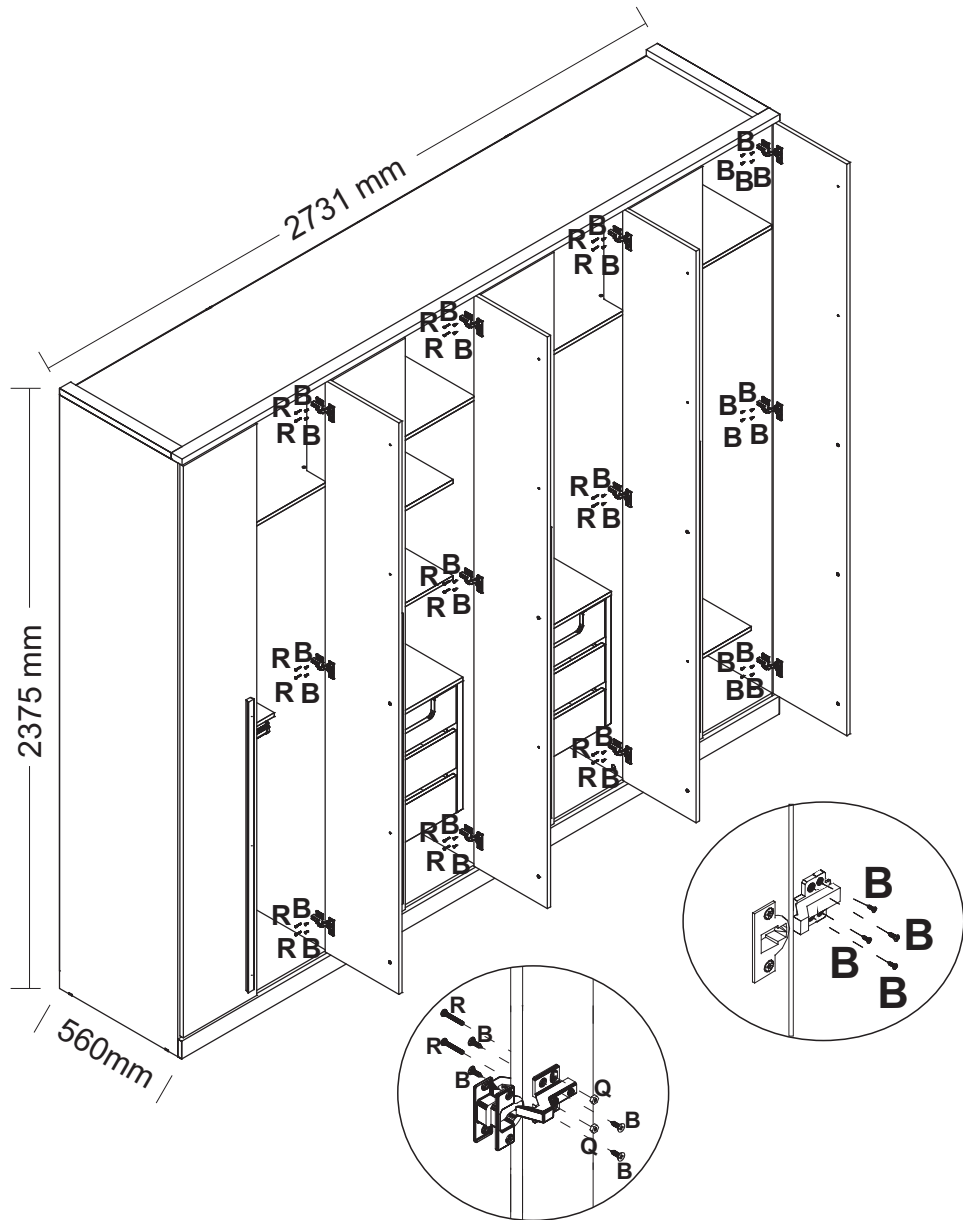

+55 (43)3538-8300

GR. ELE E ELA 08 PTS

WARDROBE ELE E ELA 08 DOORS
ROPERO ELE E ELA 08 PUERTAS

ESQUEMA DE MONTAGEM 949310-01

ASSEMBLING INSTRUCTIONS
MANUAL DE ARMADO

santos
Andirá

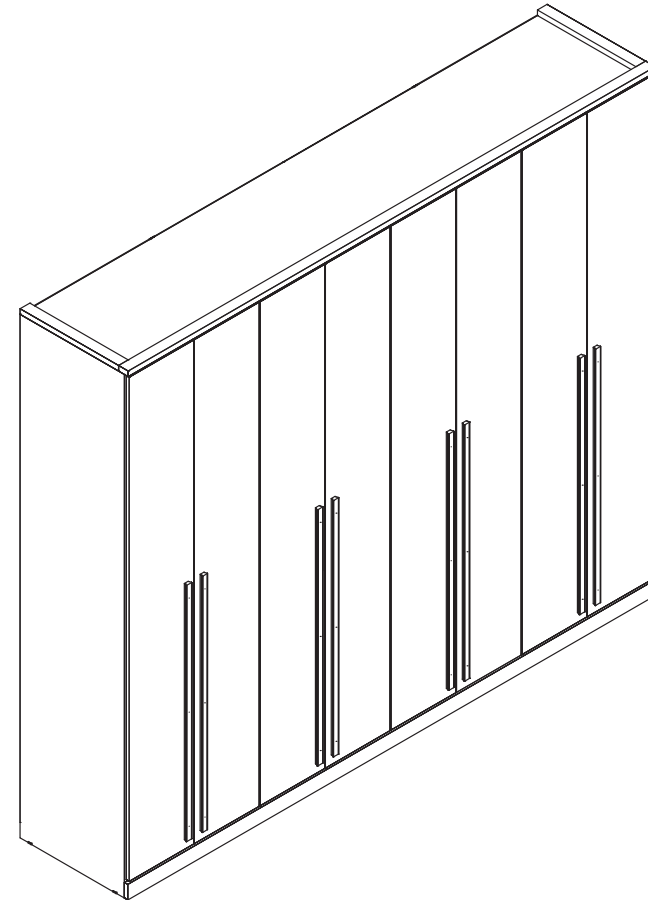

161343 • JATOBÁ/AREIA
161344 • JATOBÁ/JATOBÁ



120 minutos
120 minutes

www.santosandira.com.br

AVISO

Para limpeza do seu móvel utilize flanela seca ou levemente umedecida, sem produtos químicos!

WARNING

To clean your mobile use dry cloth or slightly moistened, no chemicals!

ADVERTENCIA

Para limpiar su mueble use un paño seco o ligeramente humedecido, sin productos químicos!



ISO 14001



ISO 9001



Descarte os resíduos de forma seletiva!

Dispose of waste selectively!

¡Deseche los residuos de manera selectiva!

Em caso de produto com espelho siga as instruções abaixo

In the case of a product with a mirror, follow the instructions below

En el caso de un producto con espejo, siga las instrucciones a continuación

Cole os espelhos na porta e aguarde cerca de 01 hora para fazer a colocação da mesma no produto.

Attach the mirrors to the door and wait about 01 hour to place it on the product.

Coloque los espejos en la puerta y espere alrededor 01 hora para colocarlos sobre el producto.

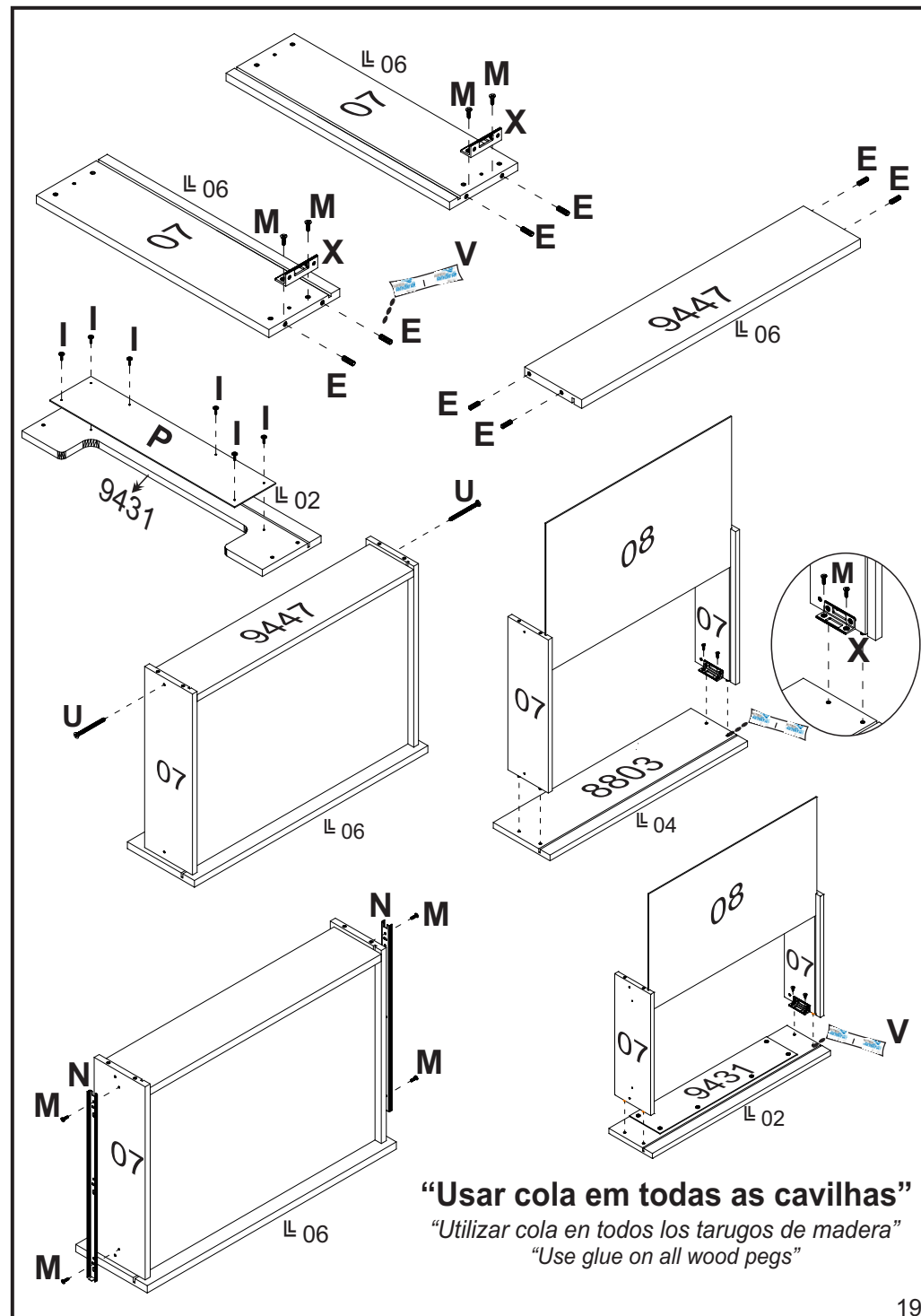

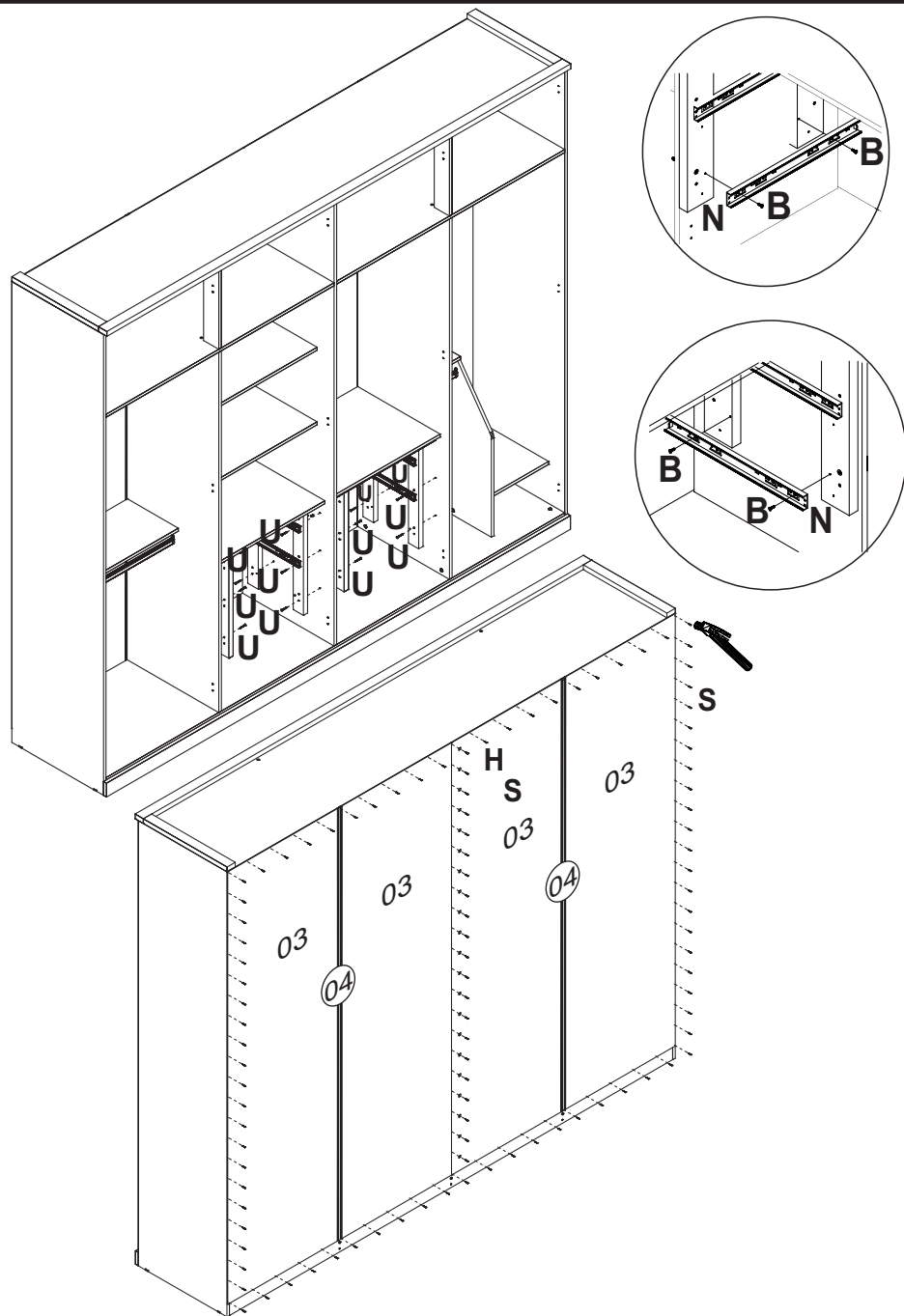

“Fixar os pregos a (100mm) de distância de um para outro”

“Fix nails to (100mm) away from one to another”

“Fije los clavos a (100 mm) lejos de uno a otro”

O peso máximo da carga exibido no desenho refere-se a objetos distribuídos de maneira uniforme sobre toda a área de contato da peça.





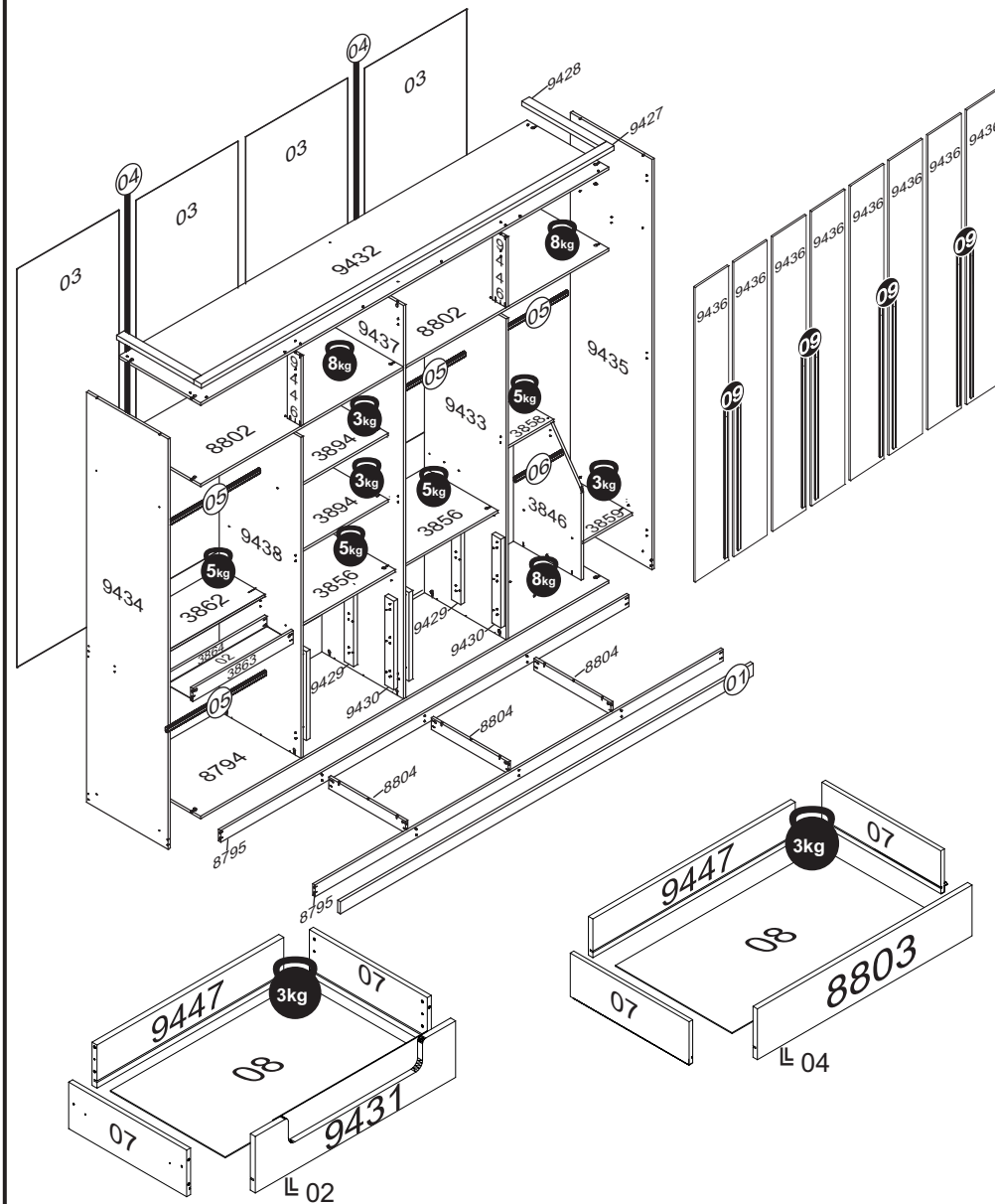

















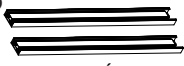

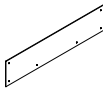

The maximum loading weight the image shows refers to objects distributed uniformly over the whole part contact area.

El peso máximo de carga informado en el diseño se refiere a objetos distribuidos uniformemente sobre totalidad de la área de contacto de la pieza.

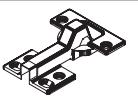

RELAÇÃO DE ACESSÓRIOS

LIST OF ACCESSORIES • LISTA DE ACCESORIOS

A 18  PARAFUSO FI CH PH 4,5x50 SCREW FI CH PH 4,5x50 TORNILLO FI CH PH 4,5x50	B 154  PARAFUSO FI CH PH 4,0x14 SCREW FI CH PH 4,0x14 TORNILLO FI CH PH 4,0x14	C 04  PINO GIROFIX 60mm GIROFIX PIN 60mm TORNILLO DEL GIROFIX 60mm	D 10  SUPORTE CABIDEIRO OB. HANGER HOLDER SOPORTE PARA PERCHERO
E 100  CAVILHA MADEIRA 6x25 WOOD PEG 6x25 TARUGO DE MADEIRA 6x25	F 37  CASTANHA GIROFIX 15x12 MINIFIX 15x12 MINIFIX 15x12	G 29  PINO GIROFIX 35mm GIROFIX PIN 35mm TORNILLO DEL GIROFIX 35mm	H 21  FIXADOR FUNDO BACKBOARD'S FIXER FIJADOR DEL COSTADO
I 12  PARAFUSO FI FL PH 3,5x14 SCREW FI FL PH 3,5x14 TORNILLO FI FL PH 3,5x14	J 14  SAPATA LAT. MINI 15mm SHOE SIDE MINI 15mm SAPATA LAT. MINI 15mm	K 04  CUNHA WEDGE CUÑA	L 01  PORTA CINTO BELT HOLDER SOPORTE PARA CORREA
M 72  PARAFUSO FI CH PH 4,0x12 SCREW FI CH PH 4,0x12 TORNILLO FI CH PH 4,0x12	N 06  CORREIÇA TELESÓPICA TELESCOPIC SLIDES RIELES TELESCÓPICO	O 06  PORCA CILÍNDRICA 12x09 CYLINDRICAL NUT 12x09 TUERCA CILÍNDRICA 12x09	P 02  ACRÍLICO 466x104x02 ACRYLIC 466x104x02 ACRILICO 466x104x02
Q 18  PORCA SX MA 4 NUT SX MA 4 TUERCA SX MA 4	R 18  PARAFUSO MQ PN PH 4,0x25 SCREW MQ PN PH 4,0x25 TORNILLO MQ PN PH 4,0x25	S 150  PREGO 10x10 NAIL 10x10 CLAVO 10x10	T 14  PREGO 12x12 NAIL 12x12 CLAVO 12x12
U 36  PARAFUSO FI CH PH 3,5x35 SCREW FI CH PH 3,5x35 TORNILLO FI CH PH 3,5x35	V 02  COLA PVA GLUE PVA COLA PVA	W 31  TAMPA GIROFIX GIROFIX COVER TAPA DEL GIROFIX	X 12  CANTONEIRA P/GAVETA DRAWER'S BRACKET CANTONEIRA PARA CAJÓN
Y 08  PARAFUSO FI PN PH 4,0x25 SCREW FI PN PH 4,0x25 TORNILLO FI PN PH 4,0x25	Z 24  DODRA 35mm C/CALCO HINGE 35mm WITH WEDGE BISAGRA 35mm C/CALZO	AA 24  PARAFUSO FI FL PH 3,5x25 SCREW FI FL PH 3,5x25 TORNILLO FI FL PH 3,5x25	AB 10  PARAFUSO FI FL PH 4,5x35 SCREW FI FL PH 4,5x35 TORNILLO FI FL PH 4,5x35

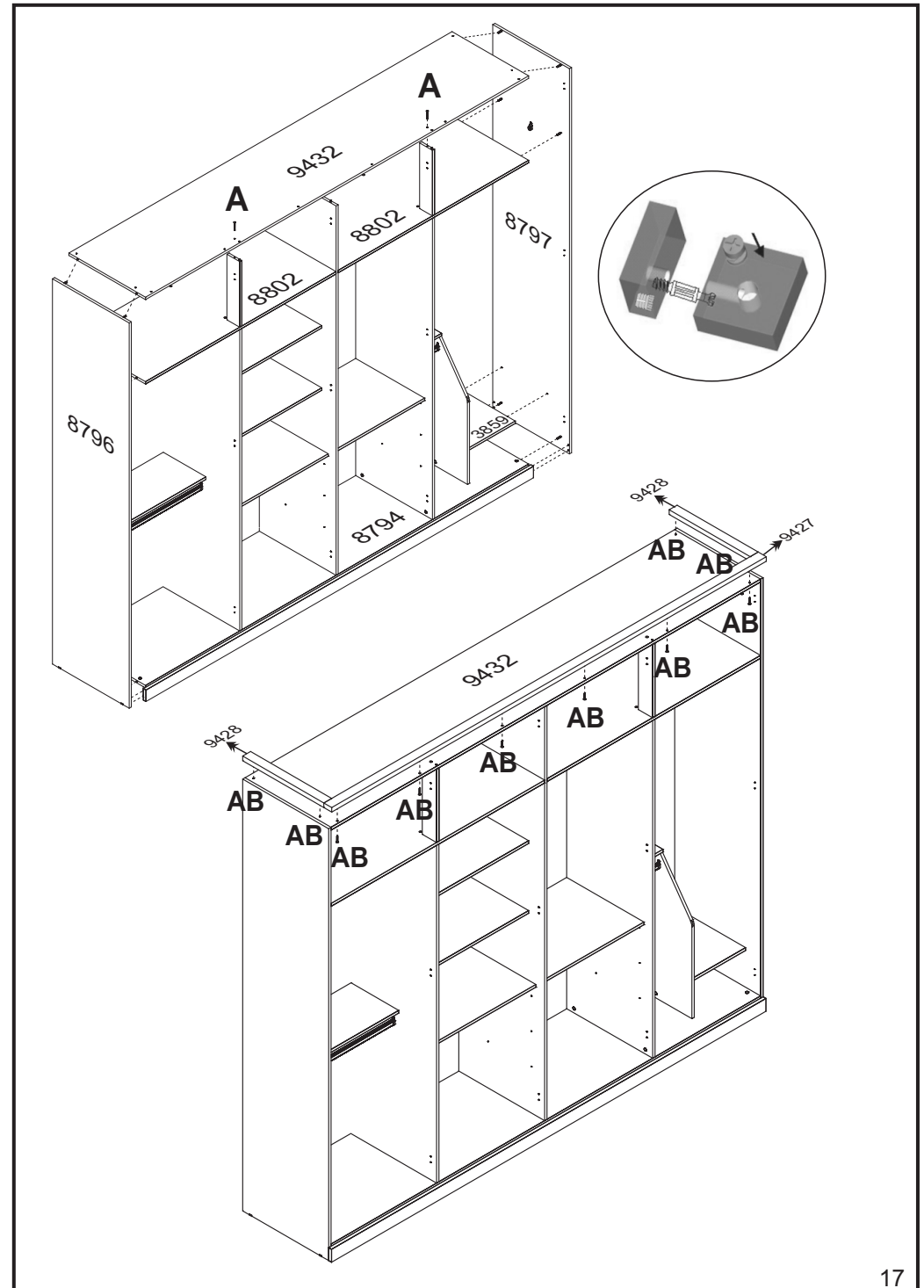

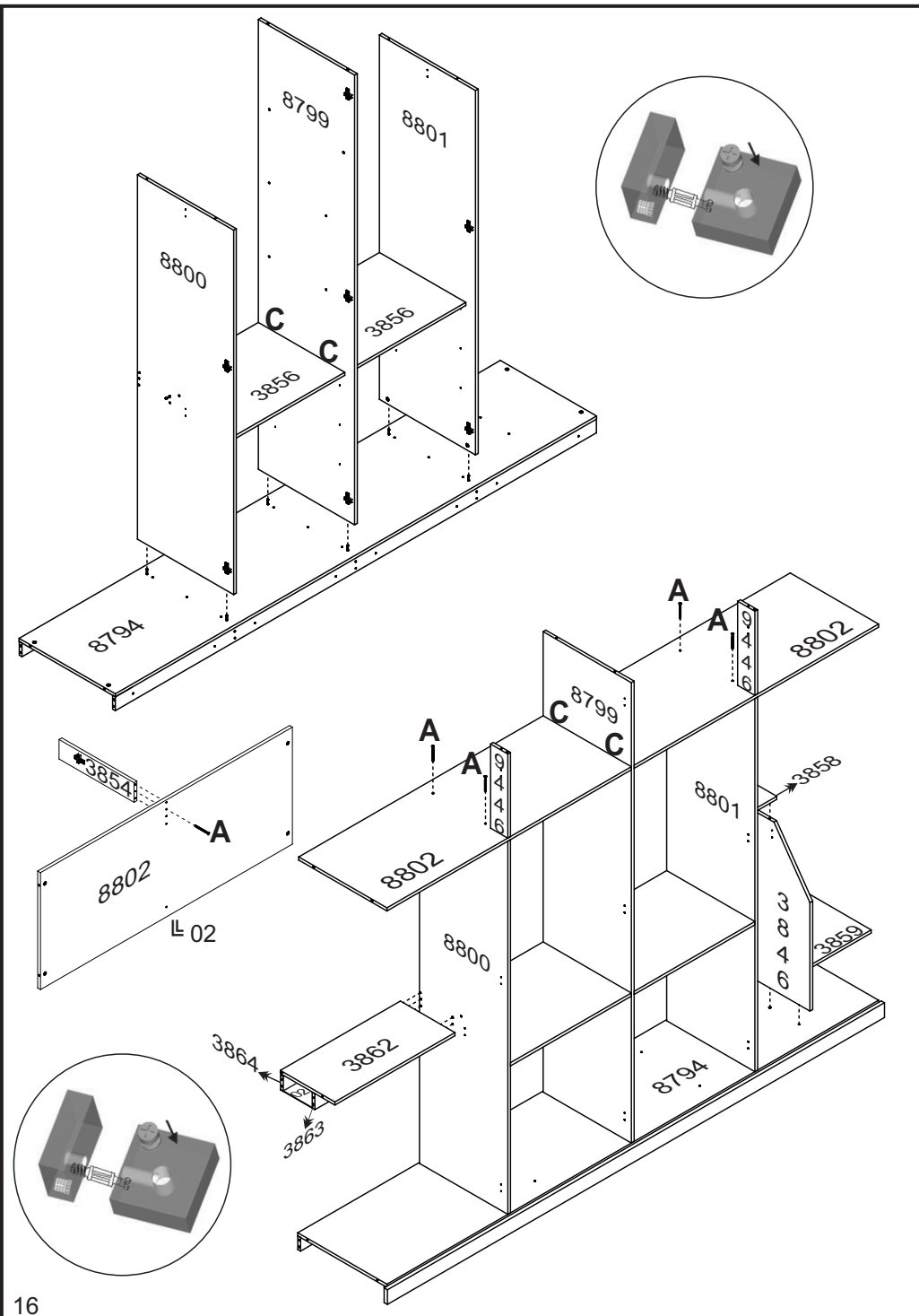

RELAÇÃO DE PEÇAS
LIST OF PARTS • LISTA DE PARTES

DESCRIÇÃO DESCRIPTION DESCRIPCIÓN	VOLUME VOLUME VOLUMEM	NÚMERO NUMBER NÚMERO	DIMENSÃO DIMENSION DIMENSION	QUANTIDADE QUANTITY CANTIDAD
VISTA INFERIOR BOTTOM FRONTAGE VISTA INFERIOR	01	01	2730x70x18	01
PERFIL H H PROFILE PERFIL H	01	04	2280mm	02
PUXADOR MDF HANDLE MDF TIRADOR MDF	01	09	1150mm	08
TAMPO DO COFRE SAFE'S COVER TAPA DEL COFRE	01	3862	662x300x15	01
BASE INF. BOTTOM BASE BASE INF.	01	8794	2701x540x15	01
RODAPÉ FRON./TRAS. FRONT/BACK BASEBOARD ZÓCALO FRON./TRAS.	01	8795	2701x067x15	02
VISTA SUPERIOR SUPERIOR FRONTAGE VISTA SUPERIOR	01	9427	2731x050x25	01
VISTA LATERAL SIDE FRONTAGE VISTA LATERAL	01	9428	510x050x25	02
DISTANCIADOR TRASEIRO BACK SPACER ESPACIADOR TRASERO	01	9429	508x062x25	04
DISTANCIADOR FRONTAL FRONT SPACER ESPACIADOR FRONTAL	01	9430	508x060x25	04
CHAPEU WARDROBE'S TOP TAPA SUPERIOR	01	9432	2701x540x15	01
DESCRIÇÃO DESCRIPTION DESCRIPCIÓN	VOLUME VOLUME VOLUMEM	NÚMERO NUMBER NÚMERO	DIMENSÃO DIMENSION DIMENSION	QUANTIDADE QUANTITY CANTIDAD
TRASEIRO G.R. WARDROBE'S BACKBOARD COSTADO DEL ROPERO	02	03	2283x676x2,5	02
PORTA DOOR PUERTA	02	9436	2262x336x15	04
DESCRIÇÃO DESCRIPTION DESCRIPCIÓN	VOLUME VOLUME VOLUMEM	NÚMERO NUMBER NÚMERO	DIMENSÃO DIMENSION DIMENSION	QUANTIDADE QUANTITY CANTIDAD
TRASEIRO G.R. WARDROBE'S BACKBOARD COSTADO DEL ROPERO	03	03	2283x676x2,5	02
PORTA DOOR PUERTA	03	9436	2262x336x15	04
DESCRIÇÃO DESCRIPTION DESCRIPCIÓN	VOLUME VOLUME VOLUMEM	NÚMERO NUMBER NÚMERO	DIMENSÃO DIMENSION DIMENSION	QUANTIDADE QUANTITY CANTIDAD
TAMPO COVER TAPA	04	3858	340x250x15	01
RODAPÉ CALÇO WEDGE BASEBOARD ZÓCALO CALZO	04	8804	509x067x15	03
LAT. INT. DIREITA RIGHT INTERNAL SIDE LAT. INTERNA DERECHA	04	9433	1838x540x15	01

RELAÇÃO DE PEÇAS
LIST OF PARTS • LISTA DE PARTES

DESCRIÇÃO DESCRIPTION DESCRIPCIÓN	VOLUME VOLUME VOLUMEM	NÚMERO NUMBER NÚMERO	DIMENSÃO DIMENSION DIMENSIÓN	QUANTIDADE QUANTITY CANTIDAD
LAT. EXT. ESQUERDA LEFT EXTERNAL SIDE LAT. EXT. IZQUIERDA	04	9434	2350x540x15	01
LAT. EXT. DIREITA RIGHT EXTERNAL SIDE LATERAL EXTERNA DERECHA	04	9435	2350x540x15	01
LAT. INT. CENTRAL CENTRAL INTERNAL SIDE LAT. INTERNA CENTRAL	04	9437	2253x540x15	01
LAT. INT. ESQUERDA LEFT INTERNAL SIDE LAT. INTERNA IZQUIERDA	04	9438	1838x540x15	01
BATENTE TOP SUPPORT BATIENTE	04	9446	400x90x15	02
DESCRIÇÃO DESCRIPTION DESCRIPCIÓN	VOLUME VOLUME VOLUMEM	NÚMERO NUMBER NÚMERO	DIMENSÃO DIMENSION DIMENSIÓN	QUANTIDADE QUANTITY CANTIDAD
FUNDO DO COFRE SAFE'S BOTTOM FONDO DEL COFRE	05	02	664x175x2,5	01
CABIDEIRO OB. FRIZADO FRIZZED OBLONG HANGER PERCHERO OB. FRIZADO	05	05	655mm	04
CABIDEIRO OB. FRIZADO FRIZZED OBLONG HANGER PERCHERO OB. FRIZADO	05	06	316mm	01
LAT. DE GAV. DRAWER'S SIDE LAT. DEL CAJÓN	05	07	357x122x12	12
FUNDO DE GAV. DRAWER'S BOTTOM FONDO DEL CAJÓN	05	08	572x352x2,5	06
DIVISÓRIA DIVISION DIVISIÓN	05	3846	800x448x15	01
TAMPO DE GAV. DRAWER'S COVER TAPA DEL CAJÓN	05	3856	664x485x15	02
PRATELEIRA SHELF ESTANTE	05	3859	445x325x15	01
TESTEIRA FRONTAL SAFE'S FRONT FRENTE DEL COFRE	05	3863	664x75x15	01
TESTEIRA TRASEIRA SAFE'S BACKBOARD TRASERO DEL COFRE	05	3864	664x70x15	01
PRATELEIRA SHELF ESTANTE	05	3894	664x440x15	02
BASE DO MALEIRO BASE FOR LUGGAGE RACK BASE DEL PORTAEQUIPAJES	05	8802	1343x540x15	02
FRENTE DE GAV. DRAWER'S FRONT FRENTE DEL CAJÓN	05	8803	607x148x15	04
FRENTE DE GAV. DRAWER'S FRONT FRENTE DEL CAJÓN	05	9431	607x148x15	02
TRASEIRO DE GAV. DRAWER'S BACKBOARD TRASERO DEL CAJÓN	05	9447	565x113x15	06

Ps: Peças e Complementos que não contém processo de furação não são enumeradas.
Parts and Accessories that do not contain drilling process and are not listed.
Piezas y Accesorios que no contienen procesos de perforación y que no numerados.

