

**MÓDULO CANTO RETO 800mm**  
MODULE STRAIGHT CORNER 800mm  
MÓDULO CANTO RECTO 800mm

**santos**  
**Andirá**

**ESQUEMA DE MONTAGEM 946008**  
ASSEMBLING INSTRUCTIONS  
MANUAL DE ARMADO

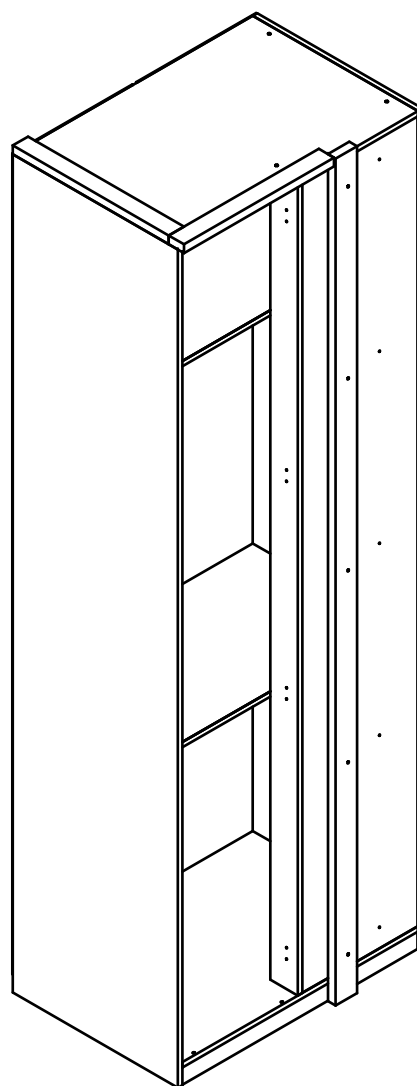
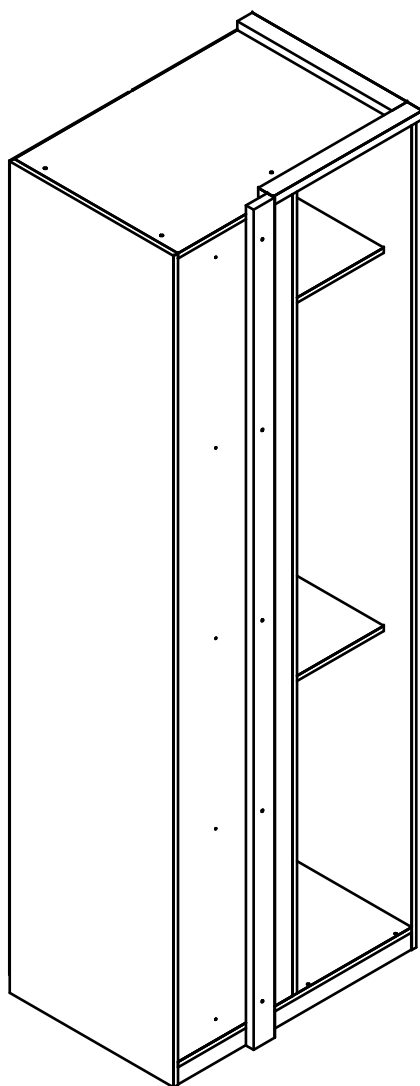

**500935 • AREIA/WOOD**  
**500978 • GRIS/WOOD**  
**500979 • WOOD/WOOD**



**120 minutos**  
120 minutes

**[www.santosandira.com.br](http://www.santosandira.com.br)**

## **AVISO**

***Para limpeza do seu móvel utilize flanela seca ou levemente umedecida, sem produtos químicos!***



## **WARNING**

*To clean your mobile use dry cloth or slightly moistened, no chemicals!*

## **ADVERTENCIA**

*Para limpiar su mueble use un paño seco o ligeramente humedecido, sin productos químicos!*

ISO 14001



ISO 9001



***Descarte os resíduos de forma seletiva!***

*Dispose of waste selectively!*

***¡Deseche los residuos de manera selectiva!***

***Em caso de produto com espelho siga as instruções abaixo:***

*In the case of a product with a mirror, follow the instructions below*

*En el caso de un producto con espejo, siga las instrucciones a continuación:*

***Cole os espelhos na porta e aguarde cerca de 01 hora para fazer a instalação da mesma no produto.***

*Glue the mirrors on the door and wait about 01 hour to install it on the product.*

*Pegue los espejos en la puerta y espere cerca de 01 hora para instalarlos.*

**O peso máximo da carga exibido no desenho refere-se a objetos distribuídos de maneira uniforme sobre toda a área de contato da peça.**

The maximum loading weight the image shows refers to objects distributed uniformly over the whole part contact area.



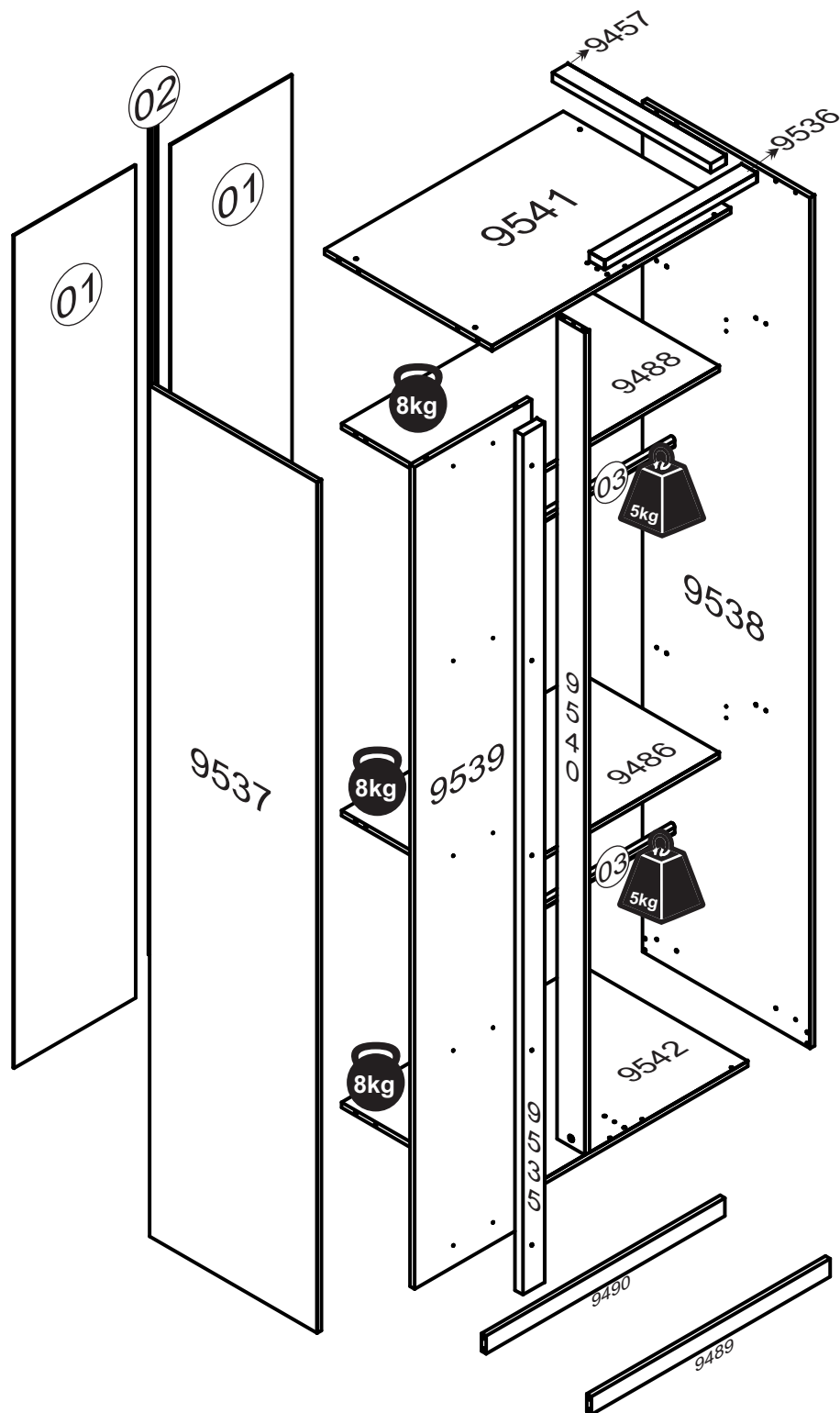







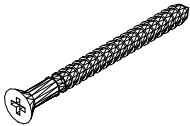

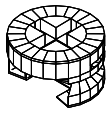
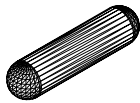
El peso máximo de carga informado en el diseño se refiere a objetos distribuidos uniformemente sobre totalidad de la área de contacto de la pieza.

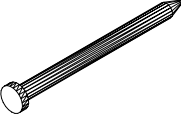

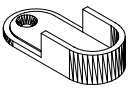
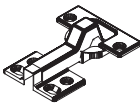
**TOTAL DE PESO SUPORTADO: 34 kg**  
TOTAL WEIGHT SUPPORTED: 34 kg  
PESO TOTAL SOPORTADO: 34 kg

# RELAÇÃO DE ACESSÓRIOS

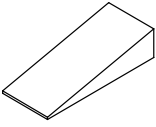
## LIST OF ACCESSORIES • LISTA DE ACCESORIOS

<p><b>A</b> <b>09</b></p>  <p><b>PARAFUSO FI CH PH 4,5x35</b> SCREW FI CH PH 4,5x35 TORNILLO FI CH PH 4,5x35</p>	<p><b>B</b> <b>56</b></p>  <p><b>PARAFUSO FI CH PH 4,0x14</b> SCREW FI CH PH 4,0x14 TORNILLO FI CH PH 4,0x14</p>	<p><b>C</b> <b>21</b></p>  <p><b>CASTANHA GIROFIX 15x12</b> MINIFIX 15x12 MINIFIX 15x12</p>	<p><b>D</b> <b>28</b></p>  <p><b>CAVILHA MADEIRA 6x25</b> WOOD PEG 6x25 TARUGO DE MADEIRA 6x25</p>
<p><b>E</b> <b>54</b></p>  <p><b>PREGO 10x10</b> NAIL 10x10 CLAVO 10x10</p>	<p><b>F</b> <b>04</b></p>  <p><b>PREGO 12x12</b> NAIL 12x12 CLAVO 12x12</p>	<p><b>G</b> <b>06</b></p>  <p><b>CANTONEIRA PLÁSTICA</b> BRACKET PLASTIC CANTONEIRA PLASTICA</p>	<p><b>H</b> <b>04</b></p>  <p><b>SUPORTE CABIDEIRO OB.</b> HANGER HOLDER SOPORTE PARA PERCHERO</p>
<p><b>I</b> <b>04</b></p>  <p><b>SAPATA REDONDA 14mm</b> ROUND SHOE 14mm SAPATA REDONDA 14mm</p>	<p><b>J</b> <b>04</b></p>  <p><b>DODRA 35mm C/CALCO</b> HINGE 35mm WITH WEDGE BISAGRA 35mm C/CALZO</p>	<p><b>K</b> <b>21</b></p>  <p><b>PINO GIROFIX 35mm</b> GIROFIX PIN 35mm TORNILLO DEL GIROFIX 35mm</p>	<p><b>L</b> <b>08</b></p>  <p><b>PARAFUSO FI CH PH 4,0x25</b> SCREW FI CH PH 4,0x25 TORNILLO FI CH PH 4,0x25</p>
<p><b>M</b> <b>20</b></p>  <p><b>TAPA FURO ADESIVO 18mm</b> HOLE COVER STICKER 18mm TAPA DEL ADHESIVO 18mm</p>	<p><b>N</b> <b>04</b></p>  <p><b>CUNHA</b> WEDGE CUÑA</p>	<p><b>O</b> <b>01</b></p>  <p><b>PARAFUSO FI CH PH 4,0x50</b> SCREW FI CH PH 4,0x50 TORNILLO FI CH PH 4,0x50</p>	

# RELAÇÃO DE PEÇAS

## LIST OF PARTS • LISTA DE PARTES

DESCRIÇÃO DESCRIPTION DESCRIPCIÓN	VOLUME VOLUME VOLUMEM	NÚMERO NUMBER NÚMERO	DIMENSÃO DIMENSION DIMENSIÓN	QUANTIDADE QUANTITY CANTIDAD
<b>TRASEIRO G.R.</b> WARDROBE'S BACKBOARD COSTADO DEL ROPERO	01	01	2325x392x2,5	02
<b>PERFIL H</b> H PROFILE PERFIL H	01	02	2325mm	01
<b>DISTANCIADOR FRONTAL</b> FRONT SPACER ESPACIADOR FRONTAL	01	9535	2400x070x025	01
<b>LAT. EXT. ESQUERDA</b> LEFT EXTERNAL SIDE LAT. EXT. IZQUIERDA	01	9537	2375x540x015	01
<b>LAT. EXT. DIREITA</b> RIGHT EXTERNAL SIDE LATERAL EXTERNA DERECHA	01	9538	2375x540x015	01
<b>FRONTAL</b> FRONTIER FRONT	01	9539	2295x377x015	01
<b>BATENTE</b> BATENT BATENTE	01	9540	2295x090x015	01
DESCRIÇÃO DESCRIPTION DESCRIPCIÓN	VOLUME VOLUME VOLUMEM	NÚMERO NUMBER NÚMERO	DIMENSÃO DIMENSION DIMENSIÓN	QUANTIDADE QUANTITY CANTIDAD
<b>CABIDEIRO OB. FRIZADO</b> FRIZZED OBLONG HANGER PERCHERO OB. FRIZADO	02	03	761mm	02
<b>VISTA LATERAL</b> SIDE VIEW VISTA LATERAL	02	9457	510x050x025	01
<b>TAMPO</b> COVER TAPA	02	9486	770x448x015	01
<b>BASE MALEIRO</b> BASE FOR LUGGAGE RACK BASE DEL PORTAEQUIPAJES	02	9488	770x448x015	01
<b>RODAPÉ FRONTAL</b> FRONT BASEBOARD ZÓCALO FRONTAL	02	9489	770x050x015	01
<b>RODAPÉ TRASEIRO</b> BACK BASEBOARD ZÓCALO TRAS.	02	9490	770x050x015	01
<b>VISTA FRONTAL</b> FRONT VIEW VISTA FRONTAL	02	9536	491x050x025	01
<b>CHAPEU</b> WARDROBE'S TOP TAPA SUPERIOR	02	9541	770x540x015	01
<b>BASE INFERIOR</b> BASE FOR LUGGAGE RACK BASE DEL PORTAEQUIPAJES	02	9542	770x540x015	01
DESCRIÇÃO DESCRIPTION DESCRIPCIÓN	VOLUME VOLUME VOLUMEM	NÚMERO NUMBER NÚMERO	DIMENSÃO DIMENSION DIMENSIÓN	QUANTIDADE QUANTITY CANTIDAD
<b>PORTA</b> DOOR PUERTA	--	----	2320x391x015	02

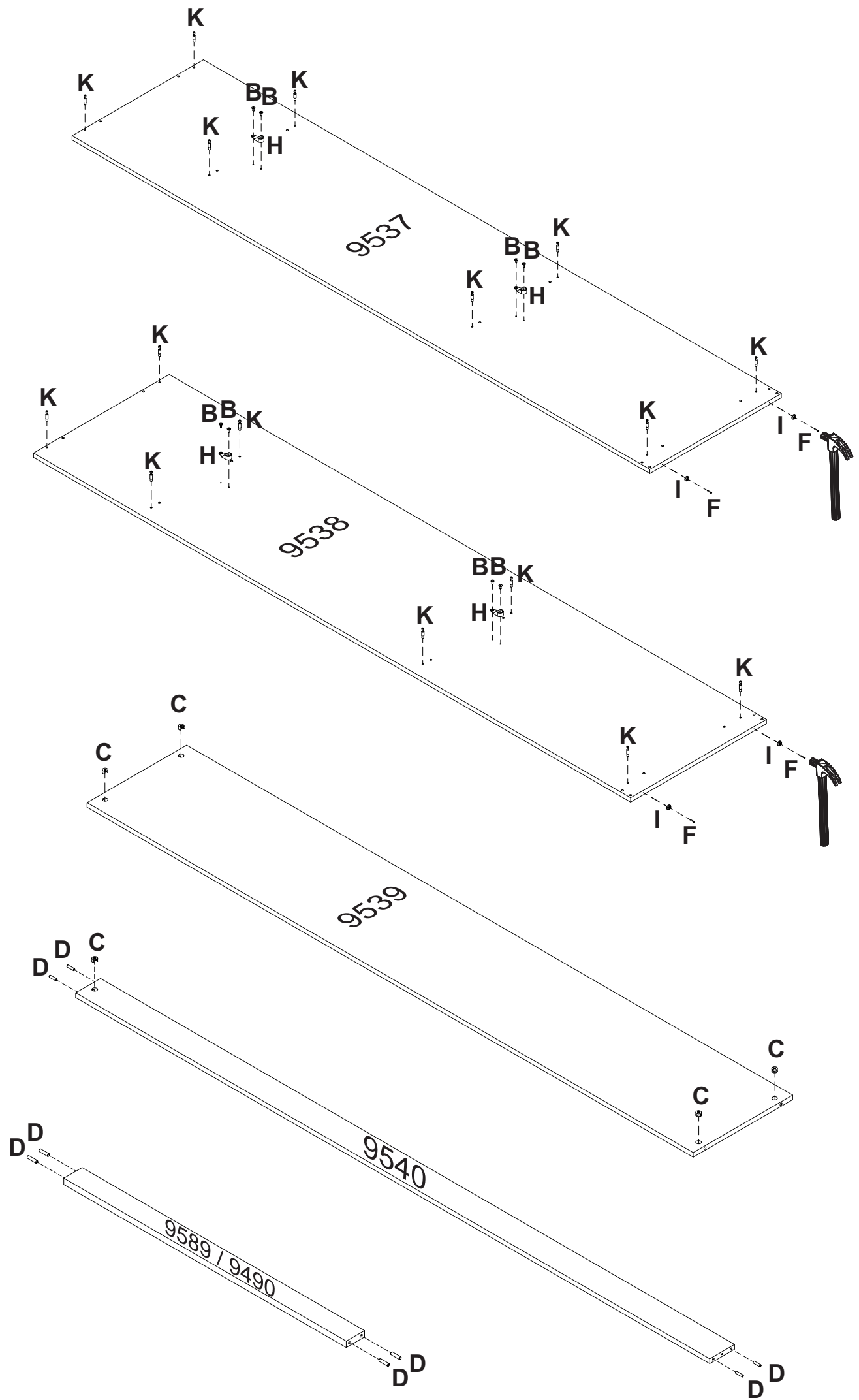

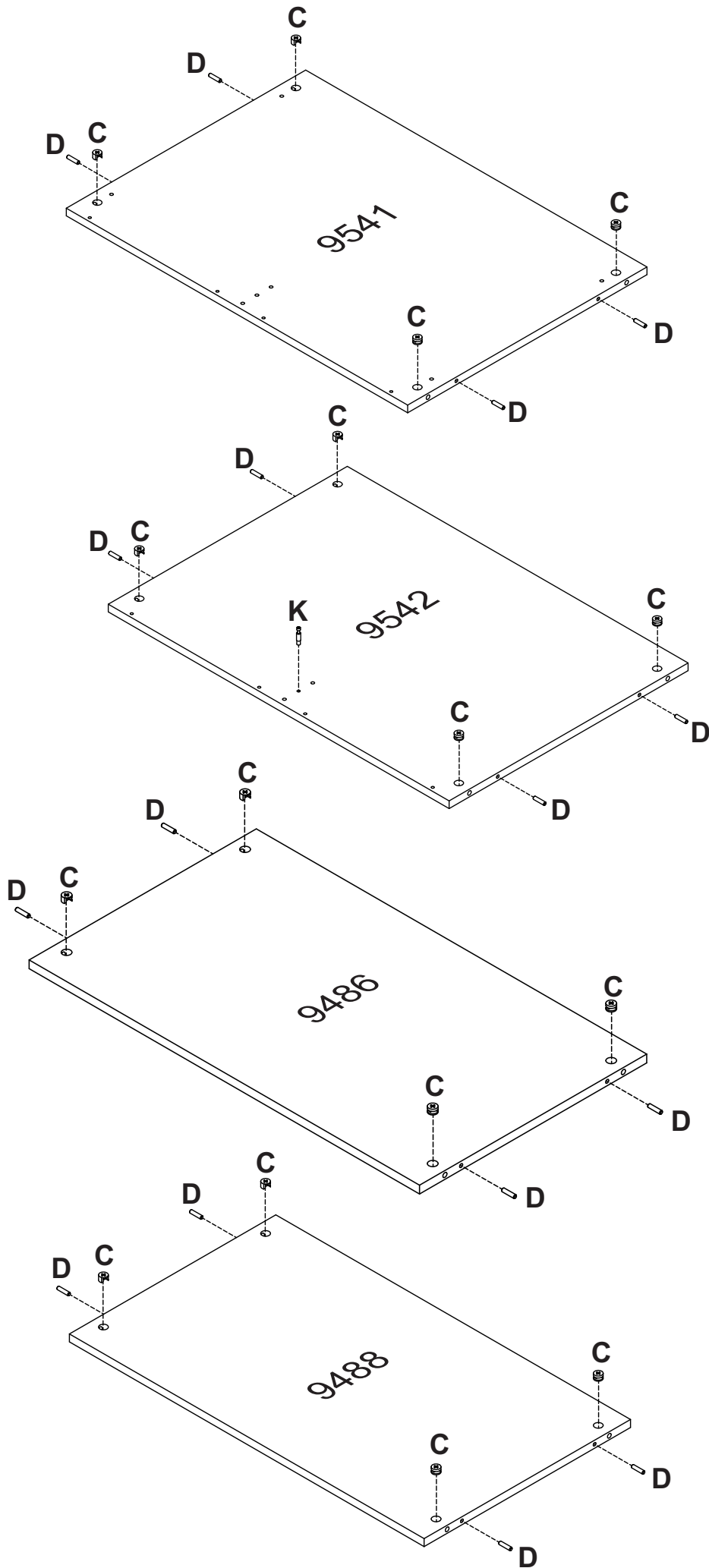

## MONTAGEM DO PRODUTO ESQUERDA

ASSEMBLY OF THE PRODUCT LEFT

PRODUCTO MONTAJE IZQUIERDA

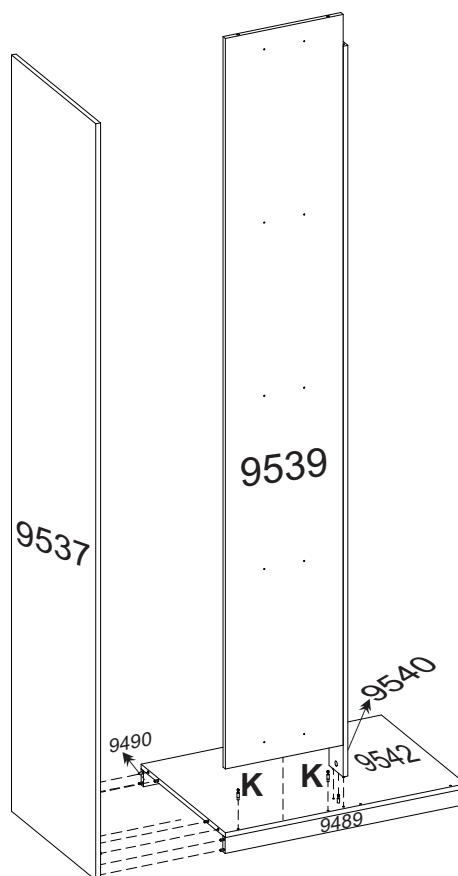
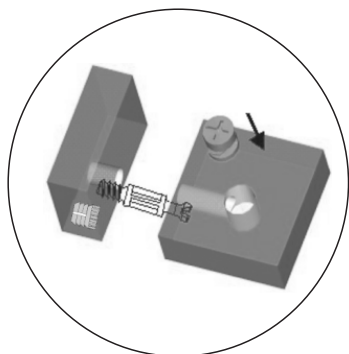

## MONTAGEM PRODUTO PARA DIREITA

ASSEMBLY OF THE PRODUCT RIGHT

MONTAJE CORRECTO DEL PRODUCTO

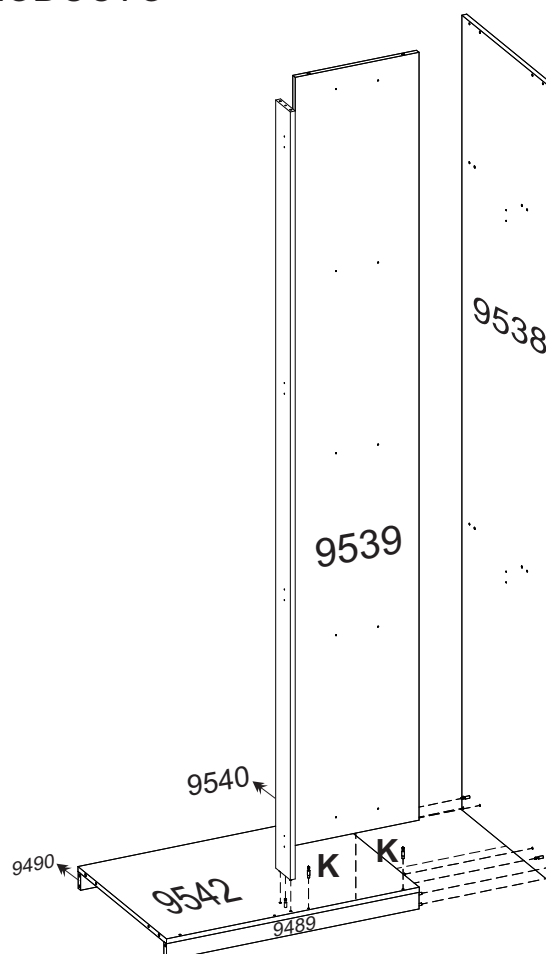
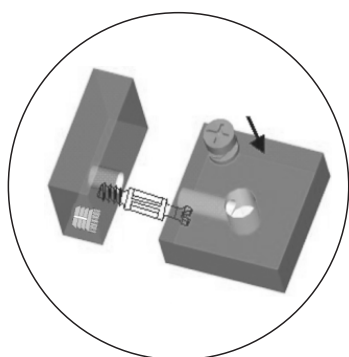



## MONTAGEM DO PRODUTO ESQUERDA

ASSEMBLY OF THE PRODUCT LEFT

PRODUCTO MONTAJE IZQUIERDA

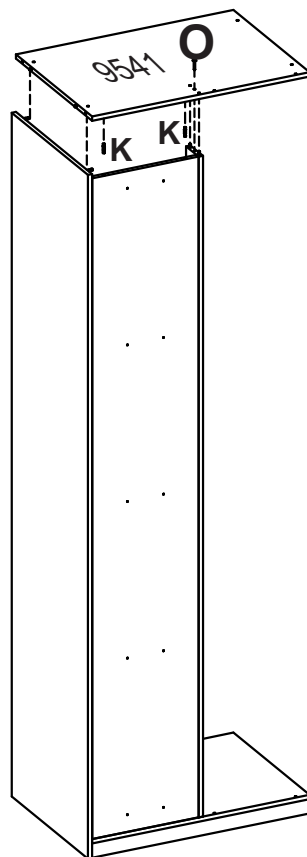
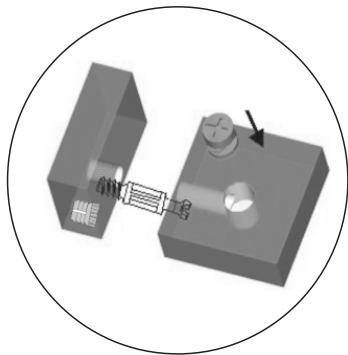

## MONTAGEM PRODUTO PARA DIREITA

ASSEMBLY OF THE PRODUCT RIGHT

MONTAJE CORRECTO DEL PRODUCTO

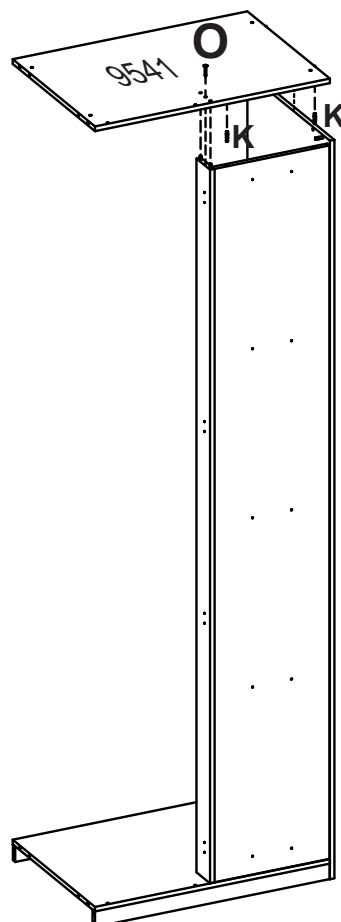
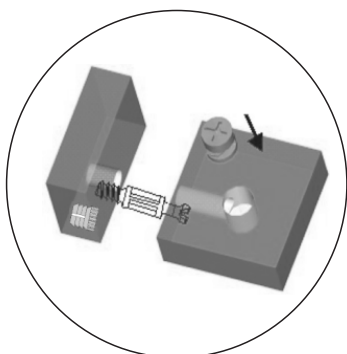

## MONTAGEM DO PRODUTO ESQUERDA

ASSEMBLY OF THE PRODUCT LEFT

PRODUCTO MONTAJE IZQUIERDA

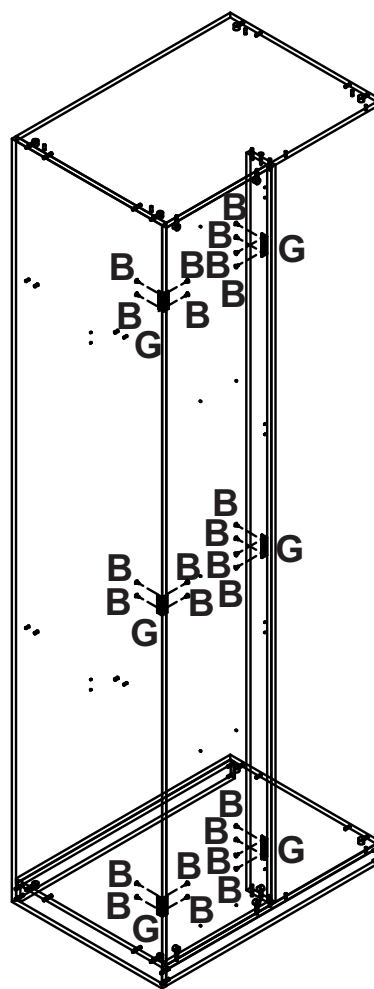

## MONTAGEM PRODUTO PARA DIREITA

ASSEMBLY OF THE PRODUCT RIGHT

MONTAJE CORRECTO DEL PRODUCTO

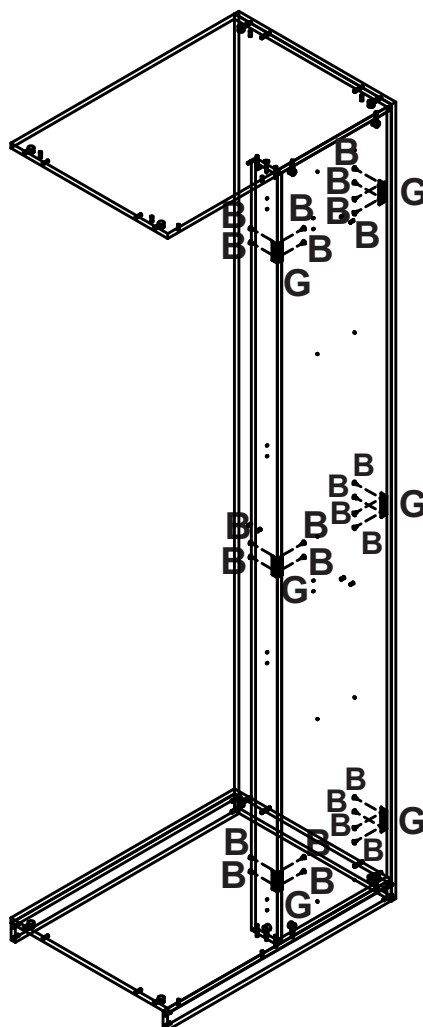

## MONTAGEM DO PRODUTO ESQUERDA

ASSEMBLY OF THE PRODUCT LEFT  
PRODUCTO MONTAJE IZQUIERDA

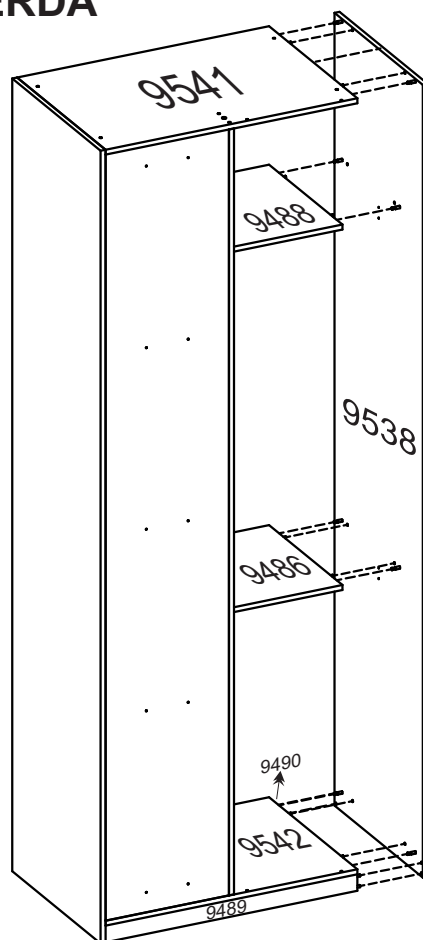

## MONTAGEM PRODUTO PARA DIREITA

ASSEMBLY OF THE PRODUCT RIGHT  
MONTAJE CORRECTO DEL PRODUCTO

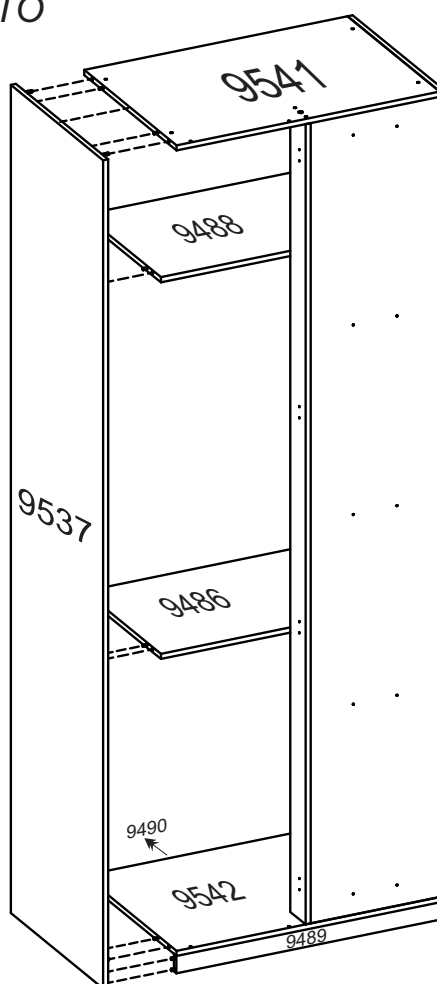

## MONTAGEM DO PRODUTO ESQUERDA

ASSEMBLY OF THE PRODUCT LEFT

PRODUCTO MONTAJE IZQUIERDA

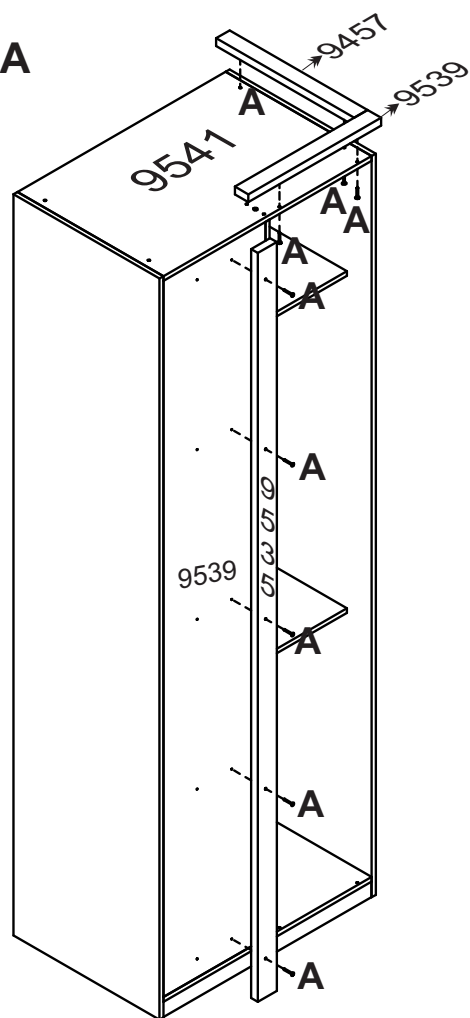

## MONTAGEM PRODUTO PARA DIREITA

ASSEMBLY OF THE PRODUCT RIGHT

MONTAJE CORRECTO DEL PRODUCTO

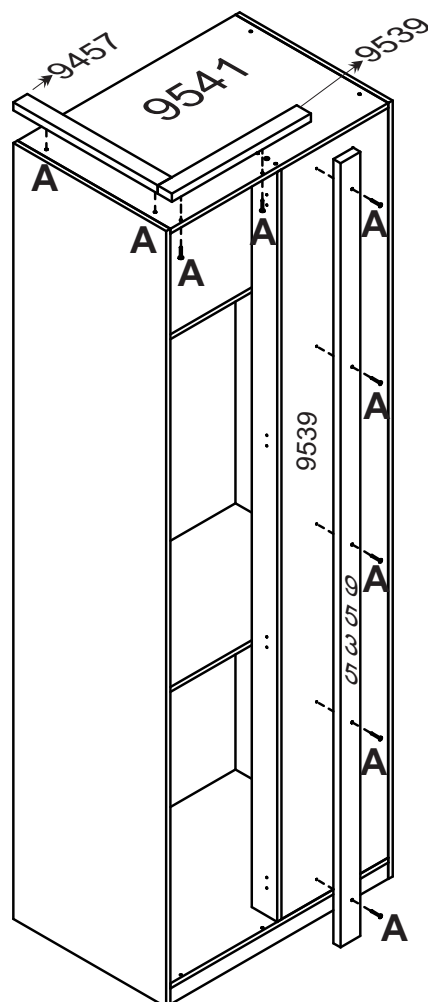

**MONTAGEM DO PRODUTO ESQUERDA**

*ASSEMBLY OF THE PRODUCT LEFT*

*PRODUCTO MONTAJE IZQUIERDA*

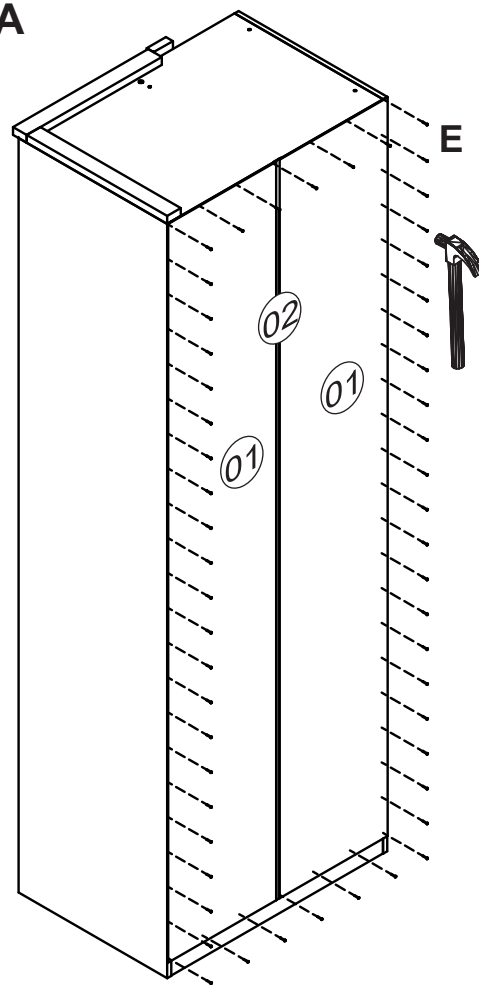

**MONTAGEM PRODUTO PARA DIREITA**

*ASSEMBLY OF THE PRODUCT RIGHT*

*MONTAJE CORRECTO DEL PRODUCTO*

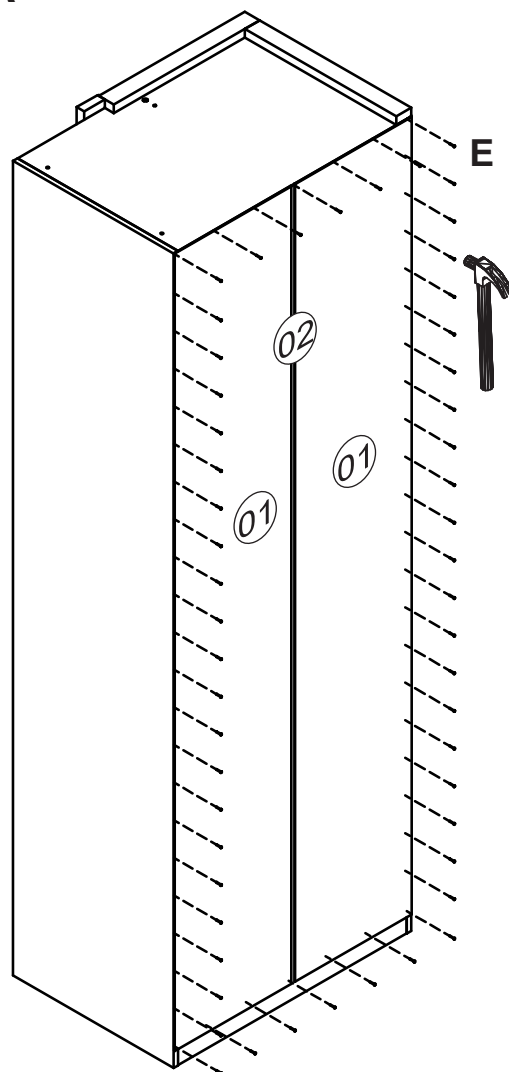

**MEDIDA DO PRODUTO MONTADO**  
*MEASURE OF THE ASSEMBLED PRODUCT*  
*MEDIDA DEL PRODUCTO ENSAMBLADO*

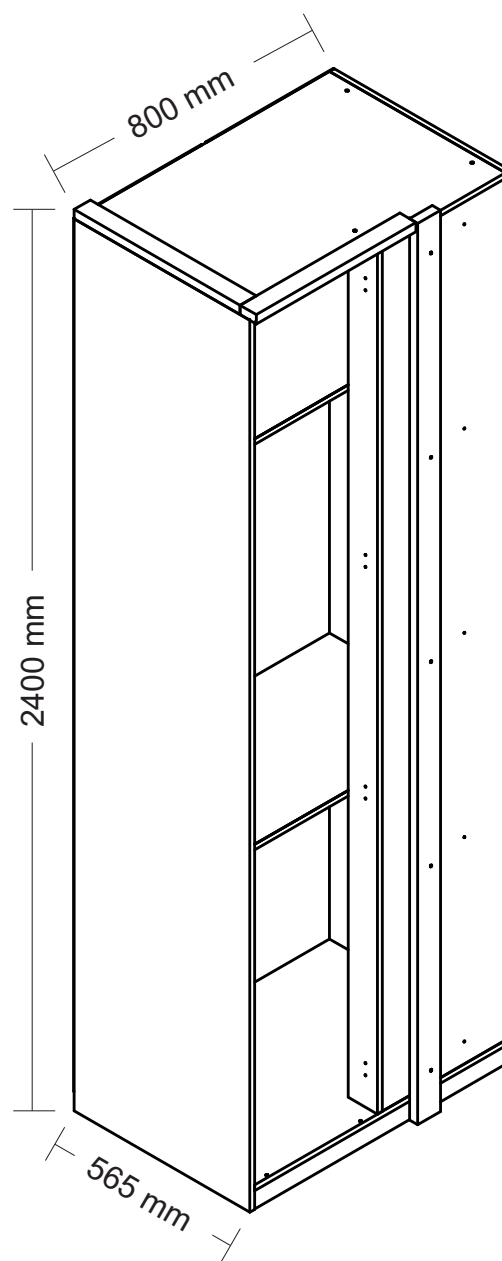
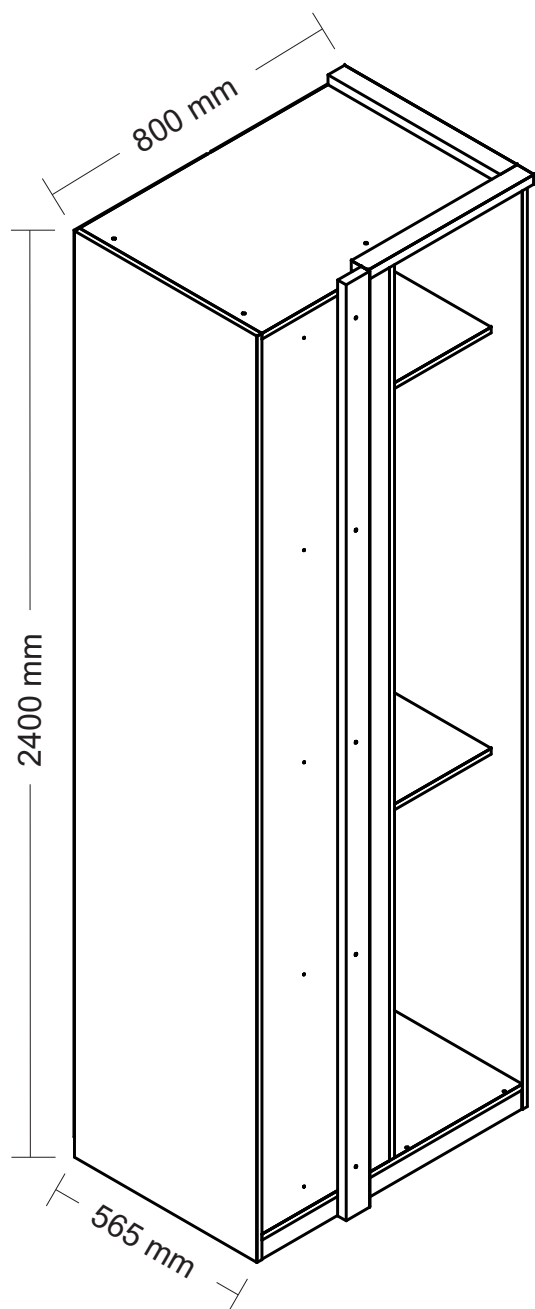

**Para união dos módulos utilizar o acessório L**  
*To join the modules, use accessory L*  
*Para unir los módulos, utilice accesorios L*

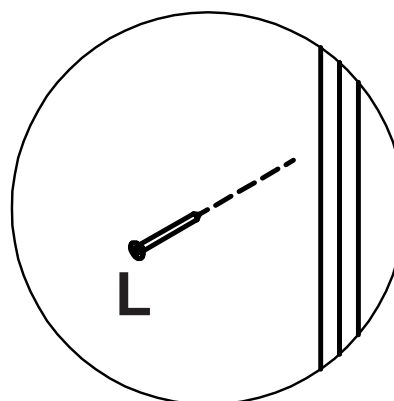

# MONTAGEM DAS PORTAS

DYOOOR ASSEMBL

MONTAJE DE LA PUERTA

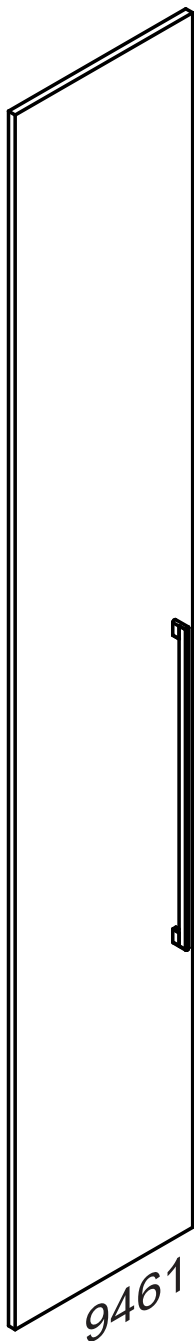
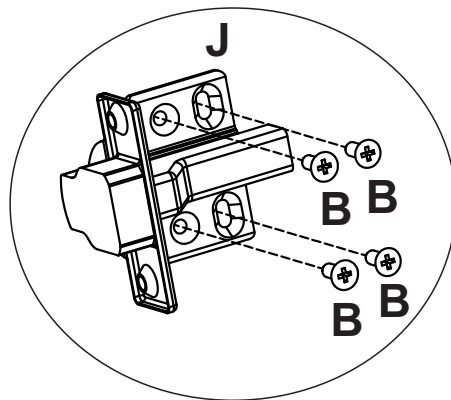

## Montagem do produto esquerda

Assembly of the product left  
Producto montaje izquierda

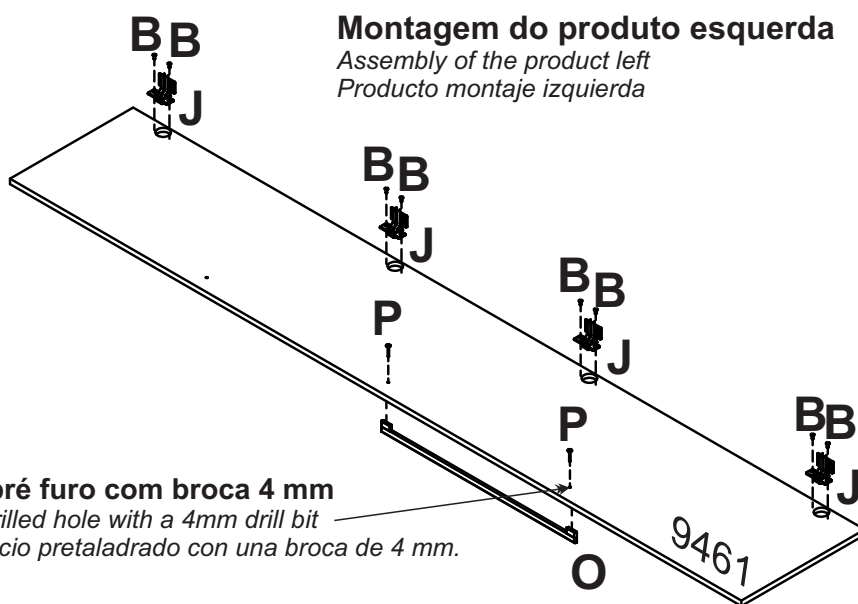

Perfurar o pré furo com broca 4 mm

Drill the pre-drilled hole with a 4mm drill bit  
Taladre el orificio pretaladrado con una broca de 4 mm.

## Montagem do produto direita

Assembly of the product right  
Montaje correcto del producto

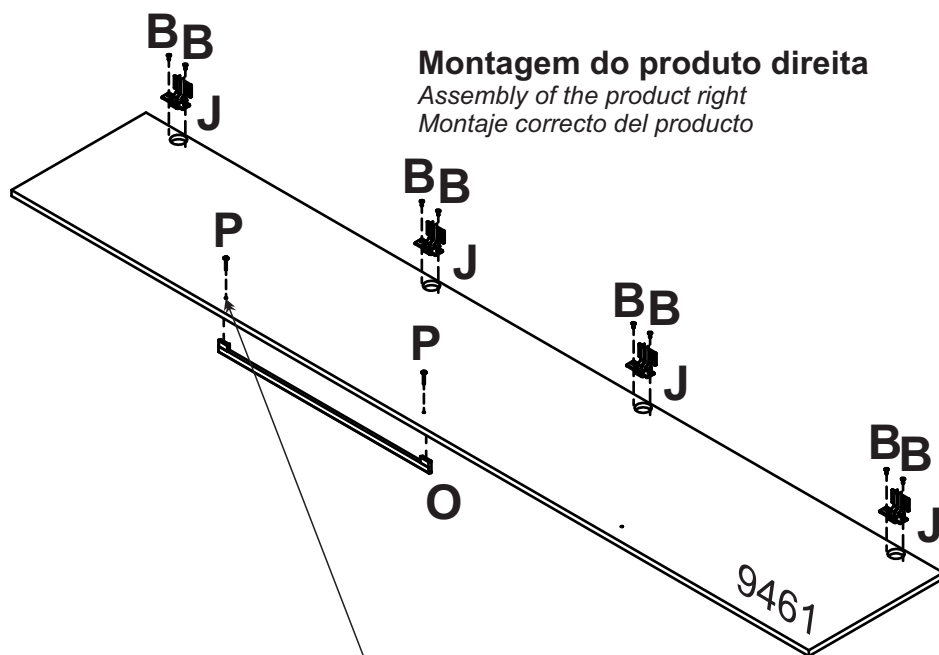

O  
01



**PUXADOR LOFT 576mm**  
LOFT PUXER 576mm  
LOFT PULLOVER 576mm

P  
02



**PARAFUSO FI FL PH 3,5x25**  
SCREW FI FL PH 3,5x25  
TORNILLO FI FL PH 3,5x25

Perfurar o pré furo com broca 4 mm

Drill the pre-drilled hole with a 4mm drill bit  
Taladre el orificio pretaladrado con una broca de 4 mm.

# MONTAGEM DAS PORTAS

DYOOOR ASSEMBL

MONTAJE DE LA PUERTA

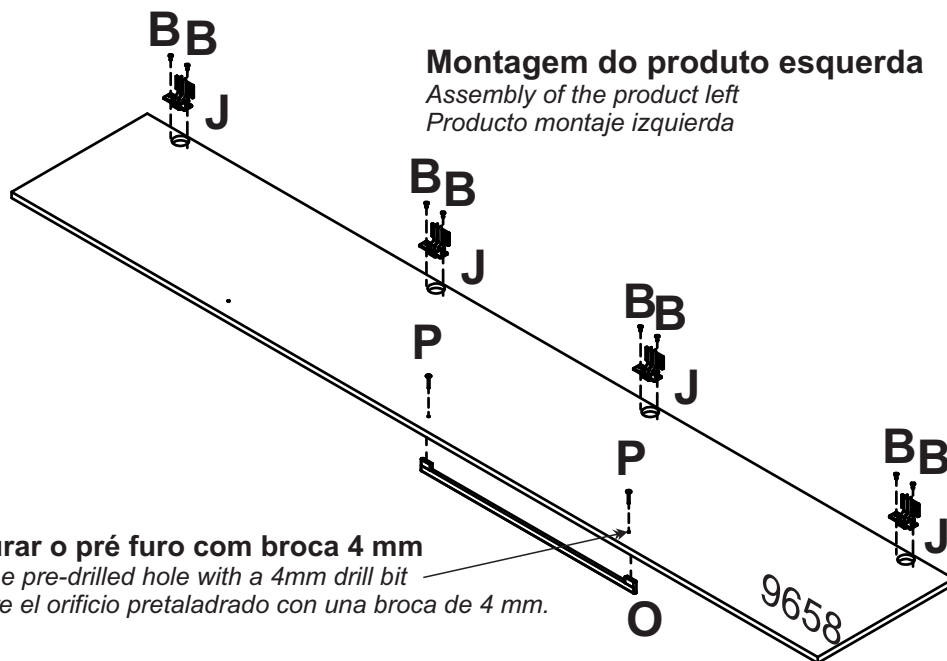
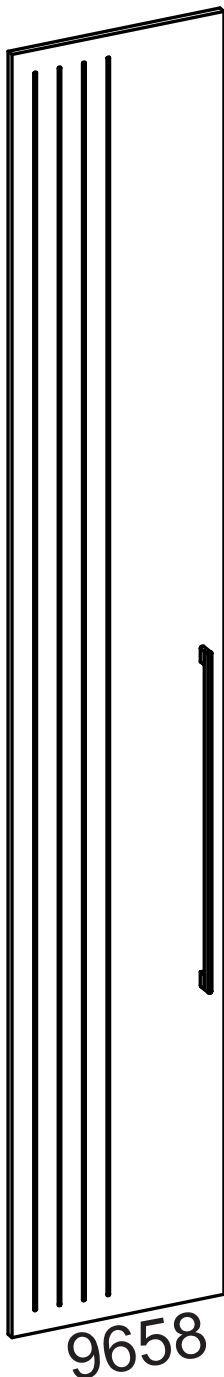
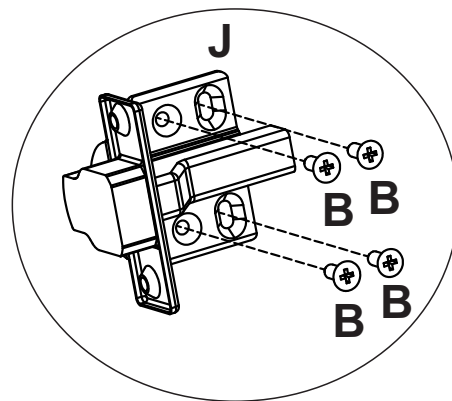

## Montagem do produto esquerda

Assembly of the product left

Producto montaje izquierda

Perfurar o pré furo com broca 4 mm

Drill the pre-drilled hole with a 4mm drill bit

Taladre el orificio pretaladrado con una broca de 4 mm.

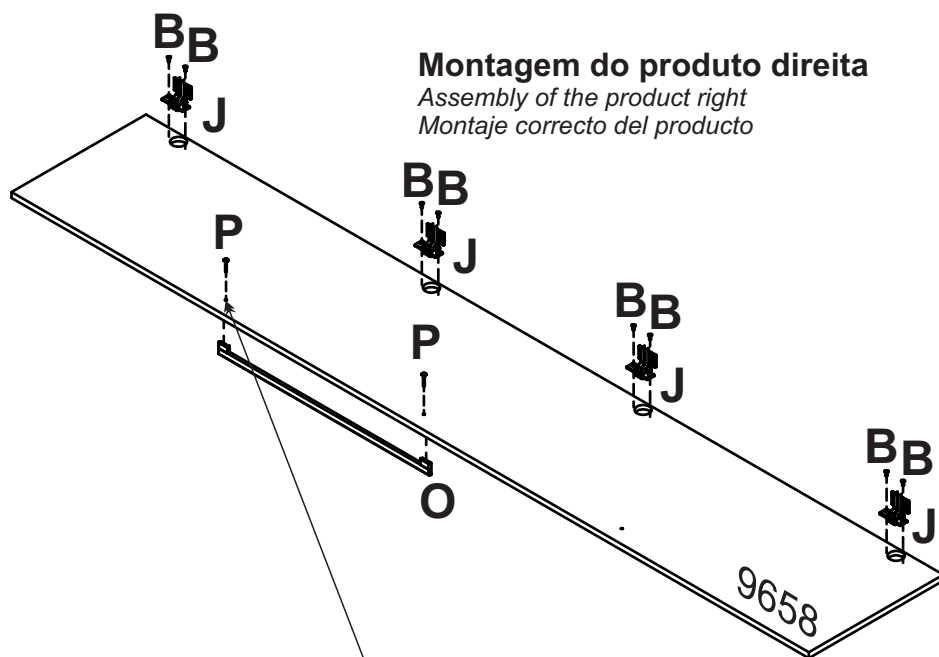

## Montagem do produto direita

Assembly of the product right

Montaje correcto del producto

O  
01



**PUXADOR LOFT 576mm**

LOFT PUXER 576mm  
LOFT PULLOVER 576mm

P  
02



**PARAFUSO FI FL PH 3,5x25**

SCREW FI FL PH 3,5x25  
TORNILLO FI FL PH 3,5x25

Perfurar o pré furo com broca 4 mm

Drill the pre-drilled hole with a 4mm drill bit

Taladre el orificio pretaladrado con una broca de 4 mm.



# MONTAGEM DAS PORTAS

DYDOOR ASSEMBL

MONTAJE DE LA PUERTA

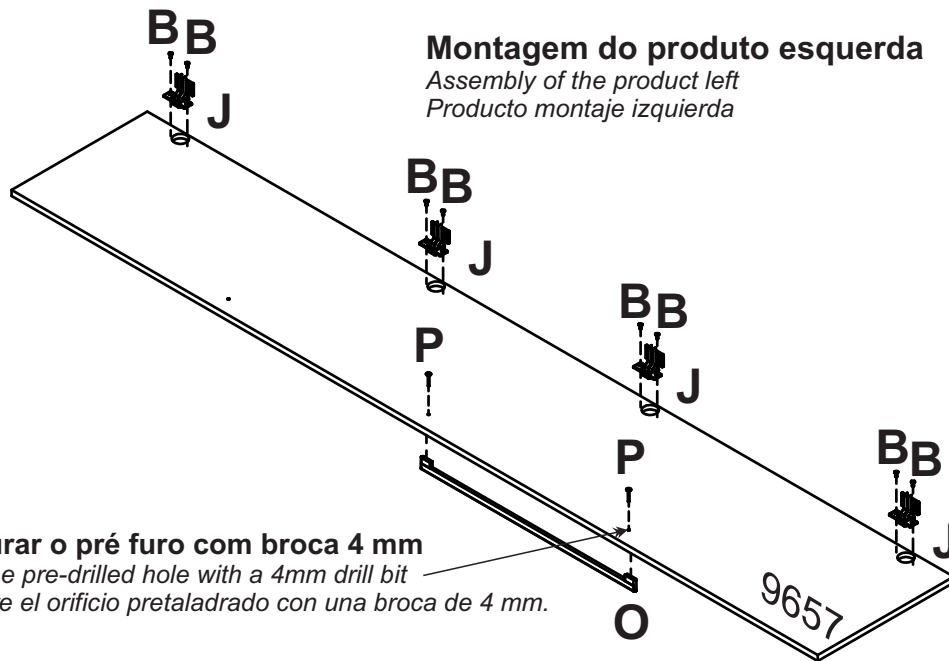
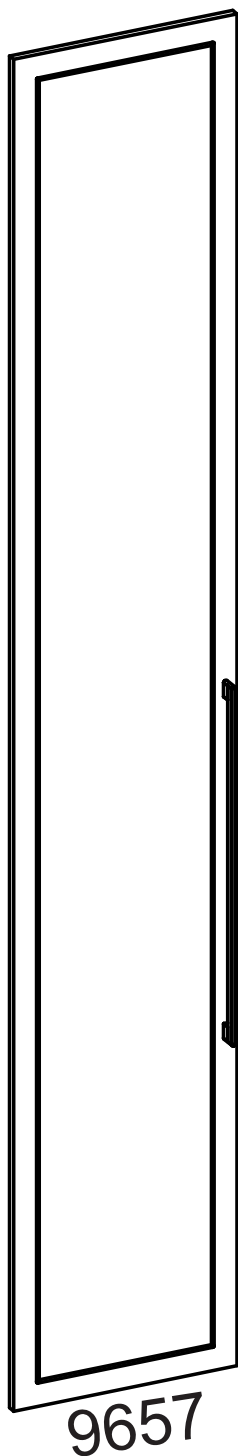
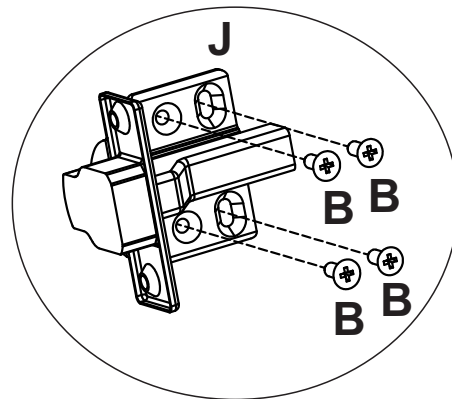

## Montagem do produto esquerda

Assembly of the product left

Producto montaje izquierda

Perfurar o pré furo com broca 4 mm

Drill the pre-drilled hole with a 4mm drill bit

Taladre el orificio pretaladrado con una broca de 4 mm.

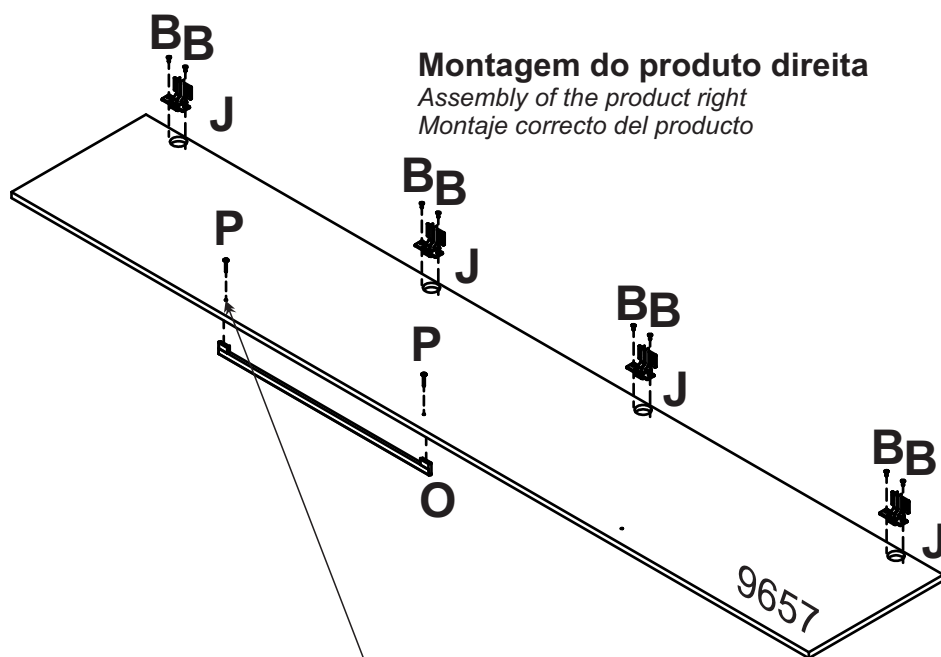

## Montagem do produto direita

Assembly of the product right

Montaje correcto del producto

Perfurar o pré furo com broca 4 mm

Drill the pre-drilled hole with a 4mm drill bit

Taladre el orificio pretaladrado con una broca de 4 mm.

O  
01



**PUXADOR LOFT 576mm**  
LOFT PUXER 576mm  
LOFT PULLOVER 576mm

P  
02



**PARAFUSO FI FL PH 3,5x25**  
SCREW FI FL PH 3,5x25  
TORNILLO FI FL PH 3,5x25

# MONTAGEM DA PORTA COM MOLDURA

DOOR ASSEMBLY WITH FRAME

ENSAMBLAJE DE PUERTA CON MARCO

**Fixe o puxador com fita dupla-face**

*Fix the handle with double-sided tape*

*Asegura el asa con cinta adhesiva de doble cara*

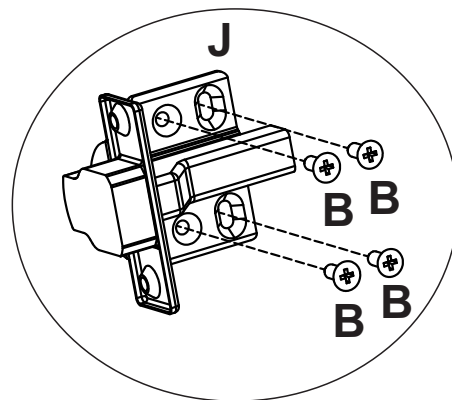
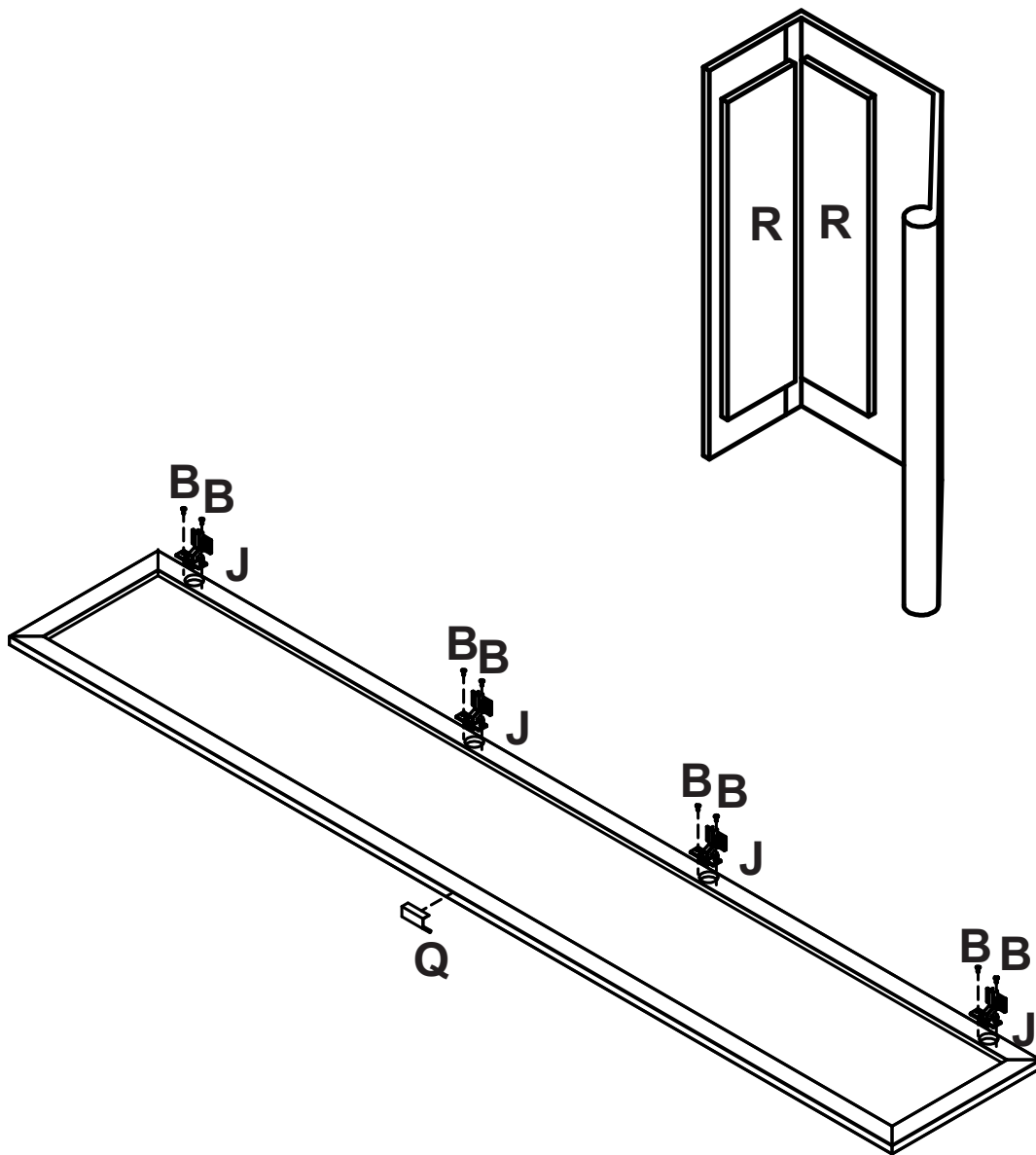
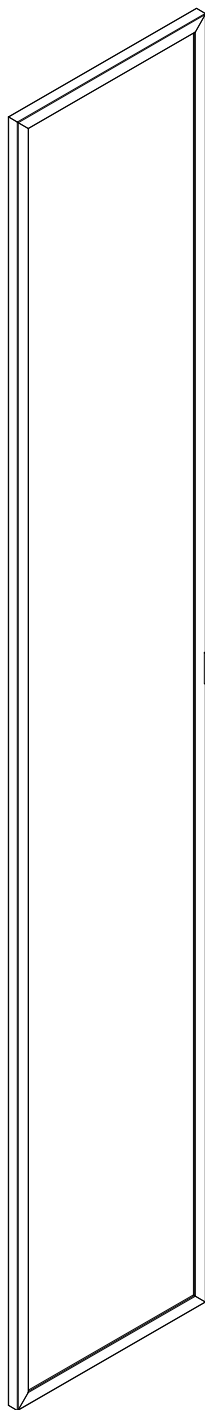

**Q**  
**01**

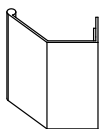

**FERFIL NOBRE 55mm**  
FERFIL NOBRE 55mm  
FERFIL NOBRE 55mm

**R**  
**02**



**DUPLA FACE**  
DOUBLE FACE  
DOBLE CARA