

MEDIDA DO PRODUTO MONTADO

MEASURE OF THE ASSEMBLED PRODUCT
MEDIDA DEL PRODUCTO ENSAMBLADO

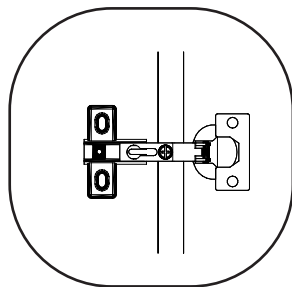
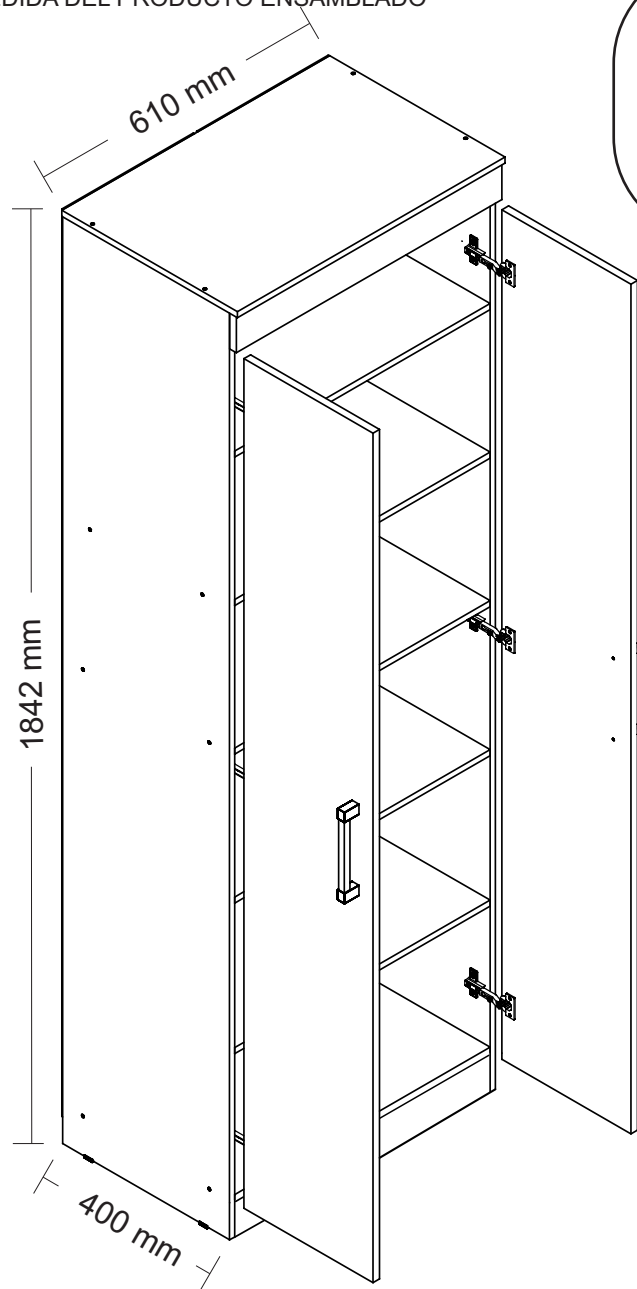

MULTIUSO STAR MODULE MULTIUSE STAR MODULO MULTIUSO STAR

ESQUEMA DE MONTAGEM 949171-05

ASSEMBLING INSTRUCTIONS
MANUAL DE ARMADO

santos
Andirá

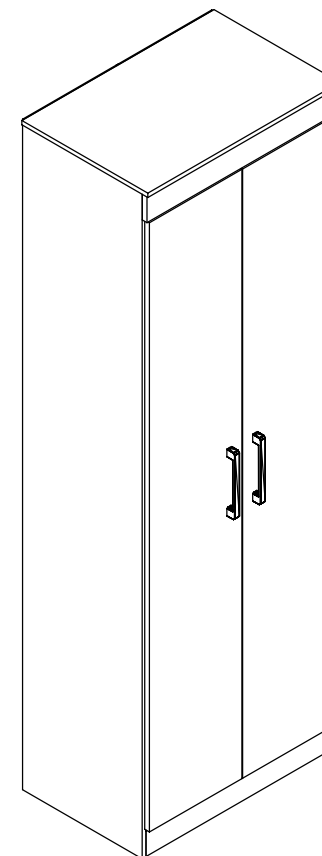

180 minutos
180 minutes

- 800255 • ATACAMA/ATACAMA
- 800258 • ATACAMA/GRAFITTE
- 800266 • BRANCO/BRANCO
- 800299 • ÉBANO/ÉBANO
- 800343 • JATOBÁ/AREIA
- 800344 • JATOBÁ/JATOBÁ
- 800348 • JATOBÁ/GRAFITTE

www.santosandira.com.br

AVISO

Para limpeza do seu móvel utilize flanela seca ou levemente umedecida, sem produtos químicos!

WARNING

To clean your mobile use dry cloth or slightly moistened, no chemicals!

ADVERTENCIA

Para limpiar su mueble use un paño seco o ligeramente humedecido, sin productos químicos!



ISO 14001



ISO 9001



Descarte os resíduos de forma seletiva!

Dispose of waste selectively!

¡Deseche los residuos de manera selectiva!

Em caso de produto com espelho siga as instruções abaixo:

In the case of a product with a mirror, follow the instructions below

En el caso de un producto con espejo, siga las instrucciones a continuación:

Cole os espelhos na porta e aguarde cerca de 01 hora para fazer a colocação da mesma no produto.

Attach the mirrors to the door and wait about 01 hour to place it on the product.

Coloque los espejos en la puerta y espere alrededor 01 hora para colocarlos sobre el producto.

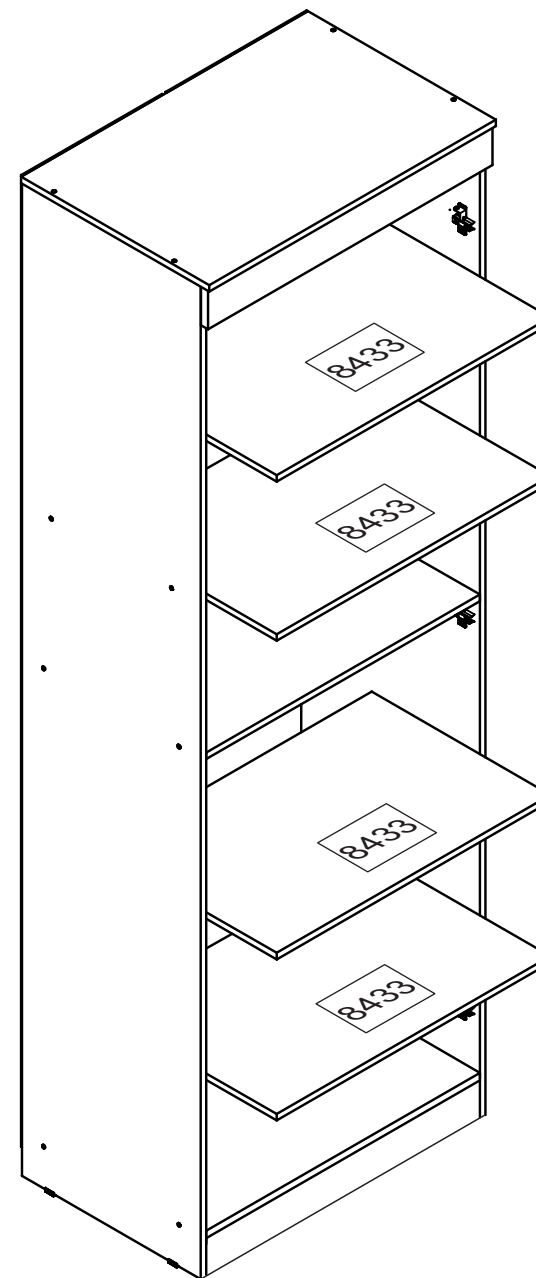

J
62



PREGO 10x10
NAIL 10x10
CLAVO 10x10

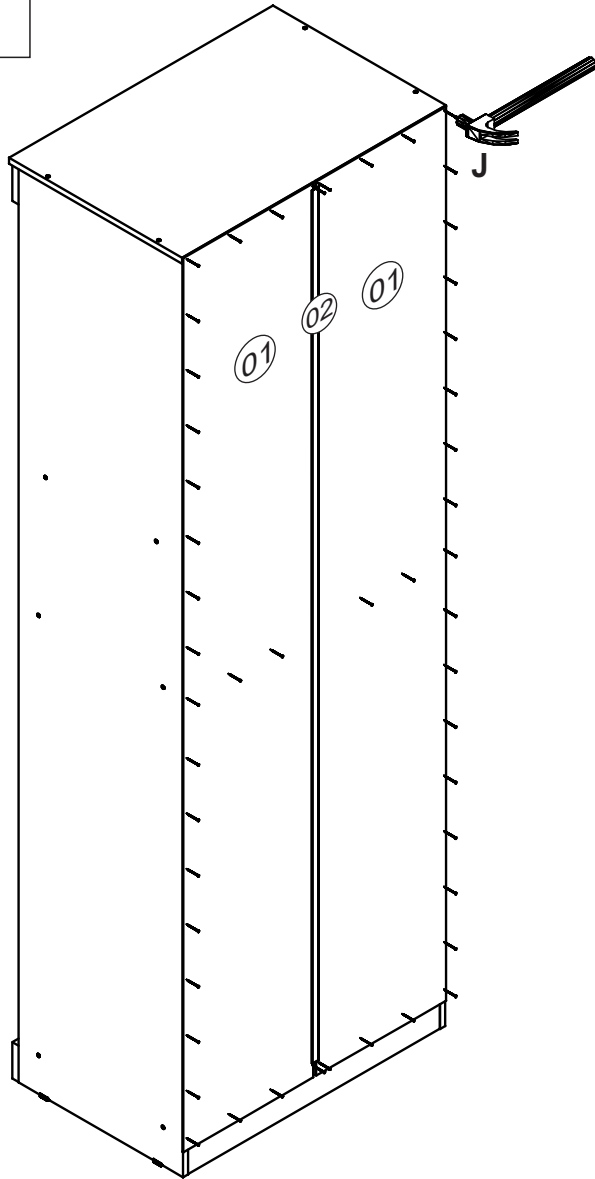



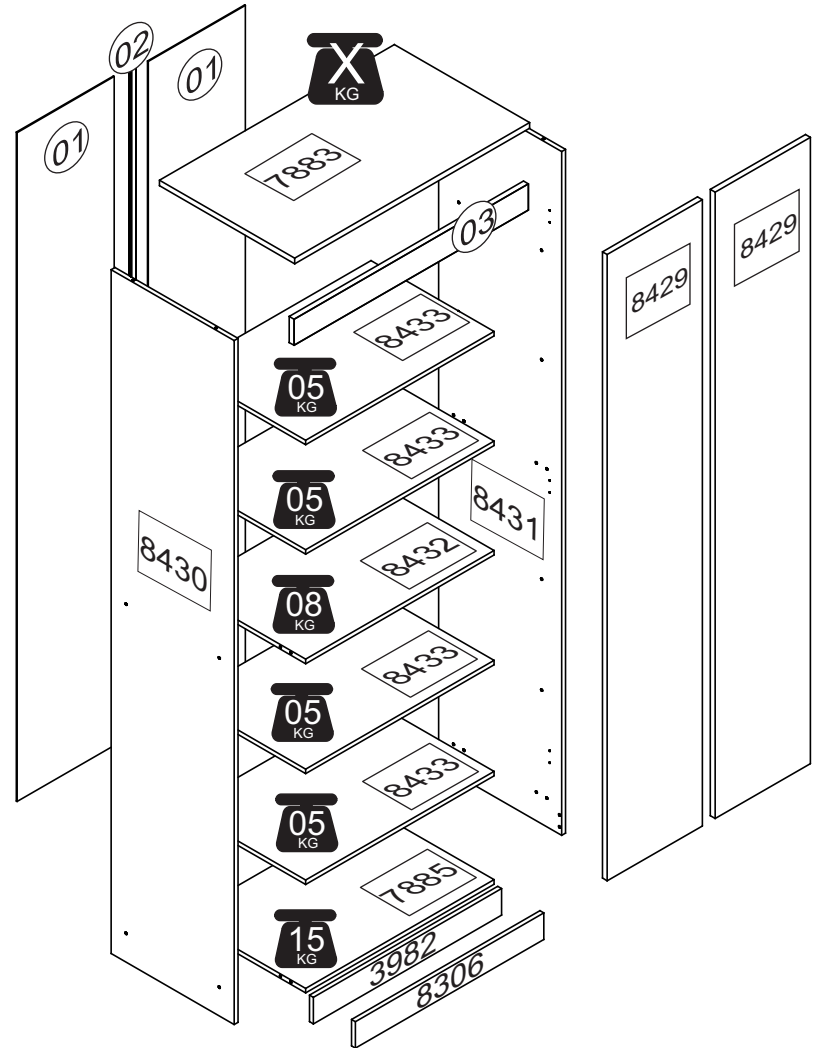

O peso máximo da carga exibido no desenho refere-se a objetos distribuídos de maneira uniforme sobre toda a área de contato da peça.

The maximum loading weight the image shows refers to objects distributed uniformly over the whole part contact area.

El peso máximo de carga informado en el diseño se refiere a objetos distribuidos uniformemente sobre totalidad de la área de contacto de la pieza.



RELAÇÃO DE ACESSÓRIOS
LIST OF ACCESSORIES • LISTA DE ACCESORIOS

<p>A 08</p>  <p>PARAFUSO FI CH PH 4,5x45 SCREW FI CH PH 4,5x45 TORNILLO FI CH PH 4,5x45</p>	<p>B 02</p>  <p>PUX. VERO 160mm HANDLE VERO 160mm TIRADOR VERO 160mm</p>	<p>C 20</p>  <p>CAVILHA MADEIRA 6x20 WOOD PEG 6x20 TARUGO DE MADEIRA 6x20</p>	<p>D 01</p>  <p>COLA PVA GLUE PVA COLA PVA</p>
<p>E 04</p>  <p>PARAFUSO FI FL PH 3,5x30 SCREW FI FL PH 3,5x30 TORNILLO FI FL PH 3,5x30</p>	<p>F 16</p>  <p>SUPORTE PRATELEIRA SUPPORT SHELF SOPORTE ESTANTE</p>	<p>G 08</p>  <p>PORCA CILINDRICA 12x09 CYLINDRICAL NUT 12x09 TUERCA CILINDRICA 12x09</p>	<p>H 08</p>  <p>CANTONEIRA METAL BRACKET METAL CANTONEIRA METAL</p>
<p>I 04</p>  <p>SAPATA LAT. MINI 12mm SHOE SIDE, MINI 12 mm SAPATA LAT. MINI 12mm</p>	<p>J 62</p>  <p>PREGO 10x10 NAIL 10x10 CLAVO 10x10</p>	<p>K 04</p>  <p>PREGO 12x12 NAIL 12x12 CLAVO 12x12</p>	<p>L 40</p>  <p>PARAFUSO FI CH ZB 4,0x12 SCREW FI CH ZB 4,0x12 TORNILLO FI CH ZB 4,0x12</p>
<p>M 04</p>  <p>CUNHA WEDGE CUNA</p>	<p>N 06</p>  <p>DOBRA METAL 26mm METAL HINGE 26mm BISAGRA METAL 26mm</p>	<p>O 06</p>  <p>CALÇO P/ DOBRA 5mm WEDGE FOR HINGE 5mm CALZO P/ BISAGRA 5mm</p>	

<p>D 01</p>  <p>COLA PVA GLUE PVA COLA PVA</p>	<p>H 02</p>  <p>CANTONEIRA METAL BRACKET METAL CANTONEIRA METAL</p>	<p>L 10</p>  <p>PARAFUSO FI CH ZB 4,0x12 SCREW FI CH ZB 4,0x12 TORNILLO FI CH ZB 4,0x12</p>
--	---	---

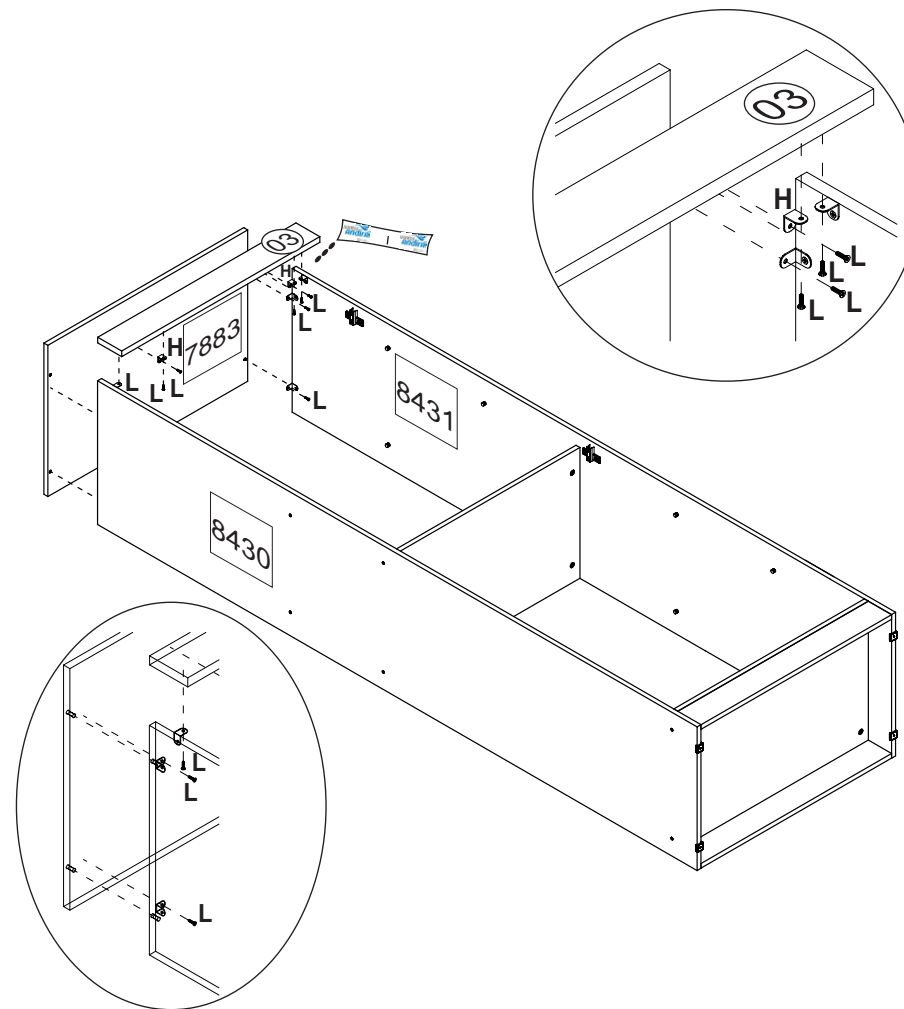

A
08

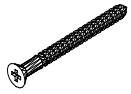



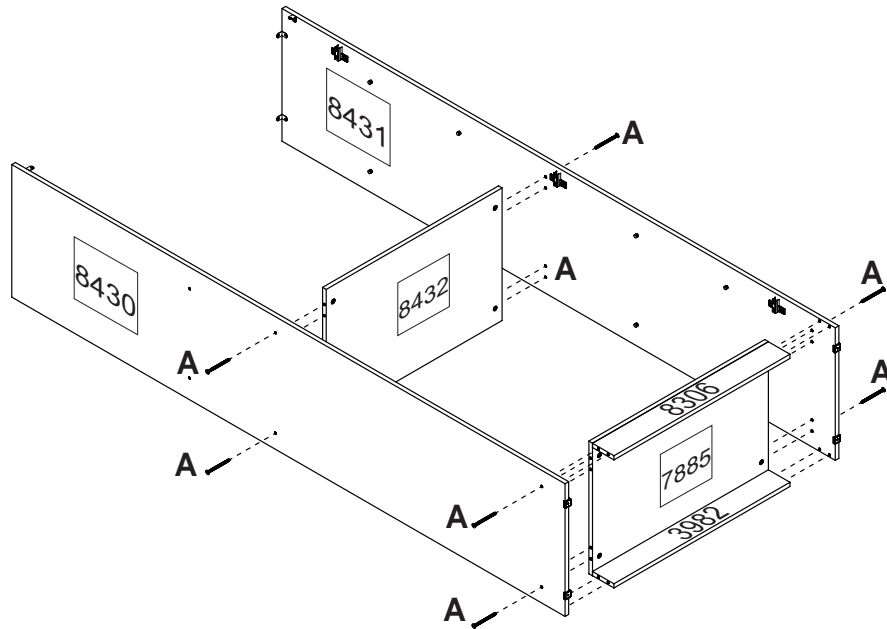



PARAFUSO FI CH PH 4,5x45
SCREW FI CH PH 4,5x45
TORNILLO FI CH PH 4,5x45





RELAÇÃO DE PEÇAS
LIST OF PARTS • LISTA DE PARTES

DESCRIÇÃO DESCRIPTION DESCRIPCIÓN	NÚMERO NUMBER NÚMERO	DIMENSÃO DIMENSION DIMENSIÓN	QUANTIDADE QUANTITY CANTIDAD
TRASEIRO BACKBOARD COSTADO	01	1790x300x2.5	02
PERFIL H SUPERIOR FRONTAGE VISTA SUPERIOR	02	1750mm	01
VISTA SUPERIOR SUPERIOR FRONTAGE VISTA SUPERIOR	03	605x73x15	01
RODAPÉ WEDGE ZÓCALO	3982	582x71x12	01
TAMPO COVER TAPA	7883	610x400x12	01
BASE INFERIOR BOTTOM BASE BASE INFERIOR	7885	582x380x12	01
RODAPÉ WEDGE ZÓCALO	8306	582x71x12	01
PORTA DOOR PUERTA	8429	1676x294x15	02
LAT.EXT.ESQUERDA LEFT EXTERNAL SIDE LAT. EXT. IZQUIERDA	8430	1830x380x12	01
LAT.EXT.DIREITA RIGHT EXTERNAL SIDE LATERAL EXTERNA DERECHA	8431	1830x380x12	01
TAMPO COVER TAPA	8432	582x350x12	01
PRATELEIRA SHELF ESTANTE	8433	582x350x12	04

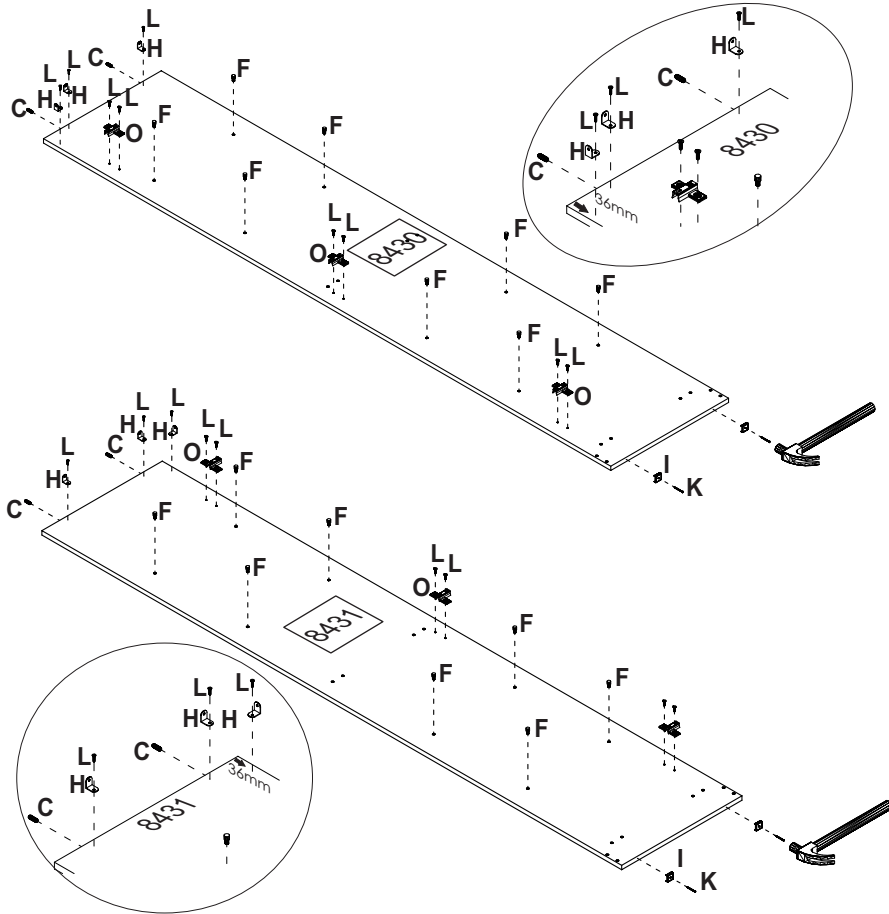
C 04  CAVILHA MADEIRA 6x20 WOOD PEG 6x20 TARUGO DE MADERA 6x20	F 16  SUPORTE PRATELEIRA SUPPORT SHELF SOPORTE ESTANTE	H 06  CANTONEIRA METAL BRACKET METAL CANTONEIRA METAL	K 04  PREGO 12x12 NAIL 12x12 CLAVO 12x12
I 04  SAPATA LAT. MINI 12mm SHOE SIDE. MINI 12 mm SAPATA LAT. MINI 12mm	L 18  PARAFUSO FI CH ZB 4,0x12 SCREW FI CH ZB 4,0x12 TORNILLO FI CH ZB 4,0x12	O 06  CALÇO P/ DOBRA 5mm WEDGE FOR HINGE 5mm CALZO P/ BISAGRA 5mm	



C 16  CAVILHA MADEIRA 6x25 WOOD PEG 6x25 TARUGO DE MADERA 6x25	G 08  PORCA CILINDRICA 12x09 CYLINDRICAL NUT 12x09 TUERCA CILINDRICA 12x09
--	--

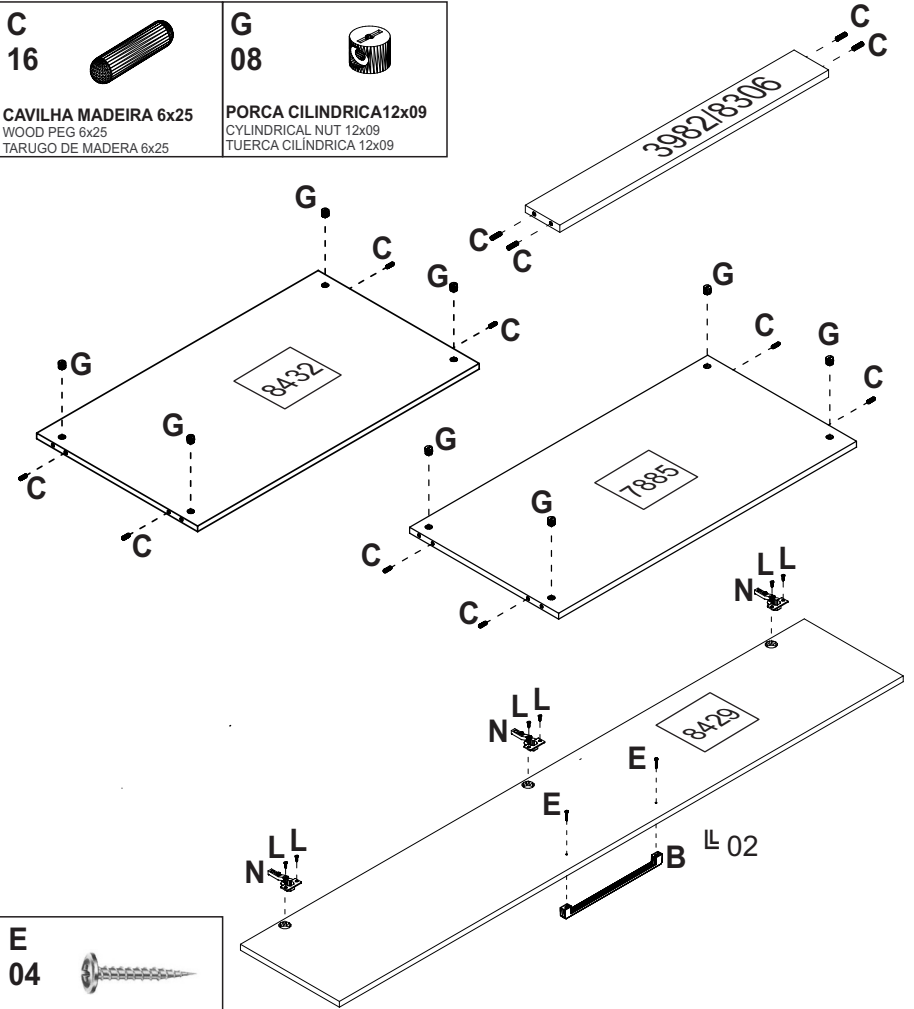

E 04  PARAFUSO FI FL PH 3,5x30 SCREW FI FL PH 3,5x30 TORNILLO FI FL PH 3,5x30

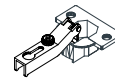
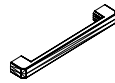
L 12  PARAFUSO FI CH ZB 4,0x12 SCREW FI CH ZB 4,0x12 TORNILLO FI CH ZB 4,0x12	N 06  DOBRA METAL 26mm METAL HINGE 26mm BISAGRA METAL 26mm	B 02  PUX. VERO 160mm HANDLE VERO 160mm TIRADOR VERO 160mm
---	--	--